

2024 Mississippi 4-H Horse Shows

MISSISSIPPI STATE
UNIVERSITY™

EXTENSION



Classes, Rules, and Regulations

Contents

| | |
|--|----|
| Conformation or In-Hand (Halter) Classes..... | 5 |
| Performance Classes..... | 5 |
| Mississippi 4-H Horse Clubs, Inc. | 7 |
| District 4-H Horse Shows | 7 |
| 2024 State 4-H Horse Contests and Show Schedule..... | 8 |
| Regional Qualifying Slots (70)..... | 11 |
| General 4-H Regulations..... | 12 |
| General Show Rules and Regulations..... | 13 |
| State Show Entry Qualifications | 15 |
| How to Measure Ponies | 16 |
| Criteria for Conformation or In-Hand (Halter) Classes 1–20 | 17 |
| Criteria for Showmanship Classes 21–26, 106–107..... | 17 |
| Method of Showing (Showmanship) | 17 |
| Ranch Ground Handling Procedures and Scoring System (Classes 106-107)..... | 19 |
| Saddle and Gaited Horse Division..... | 20 |
| Saddle and Gaited Horse Pleasure..... | 20 |
| Country Pleasure..... | 21 |
| Racking Horse | 21 |
| Saddle and Gaited Equitation | 21 |
| Saddle and Gaited Trail..... | 21 |
| Western Division..... | 23 |
| Western Pleasure | 24 |
| Western Walk/Jog..... | 25 |
| Special Needs Walk/Jog Horsemanship | 25 |
| Special Needs Walk/Jog Horsemanship Pattern..... | 26 |
| Western Riding..... | 26 |
| Western Riding Pattern Number 1 | 27 |
| Western Riding Pattern Number 2 | 27 |
| Western Riding Pattern Number 4 | 28 |
| Western Horsemanship..... | 28 |
| Western Trail | 30 |
| Special Needs Walk/Jog Trail..... | 32 |
| Special Needs Walk/Jog Trail Pattern 1..... | 32 |
| Reining..... | 32 |
| Reining Pattern Number 1 | 33 |
| Reining Pattern Number 2..... | 34 |
| Reining Pattern Number 4..... | 34 |
| Reining Pattern Number 9..... | 35 |
| Reining Pattern Number 11 | 35 |
| Working Cow Horse (Boxing Only)..... | 36 |
| Miniature In Hand Classes..... | 37 |
| Hunter Division..... | 38 |
| Hunter Under Saddle (Bridle Path Hack) | 39 |
| Hunter Under Saddle Walk/Trot..... | 40 |
| Hunt Seat Equitation on the Flat..... | 41 |
| Ponies Entered in Over Fences Classes..... | 42 |
| Cross Rails..... | 42 |
| Working Hunter | 43 |
| Equitation Over Fences | 43 |
| Jumping | 44 |
| Dressage | 45 |
| Speed Events..... | 52 |
| Pole Bending..... | 52 |
| Pole Bending Pattern | 52 |

| | |
|---|----|
| Barrel Racing..... | 53 |
| Barrel Racing Pattern..... | 53 |
| Stake Race..... | 54 |
| Acceptable Stake Race Patterns..... | 54 |
| Roping..... | 55 |
| Calf Roping | 55 |
| Breakaway Roping..... | 56 |
| Dally Team Roping | 56 |
| Goat Tying..... | 57 |
| Ranch Horse Division..... | 58 |
| Ranch Riding | 58 |
| Ranch Riding Pattern 1..... | 58 |
| Ranch Riding Pattern 2..... | 59 |
| Ranch Riding Pattern 3..... | 59 |
| Ranch Riding Pattern 4..... | 60 |
| Ranch Trail | 61 |
| Ranch Roping | 63 |
| Ranch Pleasure | 64 |
| Ranch Sorting..... | 64 |
| Awards for State Show | 65 |
| Qualifying Horses for Regional Show | 66 |
| County Stall Decoration/Display Contest..... | 66 |
| Horse Art Contest | 67 |
| Horse Photography Contest..... | 68 |
| Horse T-shirt Design Contest | 69 |
| Swazye Woodruff Memorial All-Around Award | 71 |

NOTE: Underlined text throughout this book depicts changes made from the 2023 MS 4-H Horse Show Classes, Rules, and Regulations book.

Procedure for Changing Rules and Regulations for the Mississippi State 4-H Horse Show

To inform participants in the 4-H horse program about how rules and regulations are proposed each year, this information has been put together to explain this process, when these meetings occur, and how you can participate in these meetings.

1. The four district 4-H horse shows are held in mid-June, as determined by each district. The Mississippi State 4-H Horse Show is held in late June each year.
2. Before or after the horse shows, each county horse club meets to talk about recommendations they have for the next year. The county horse club then sends one voting delegate to its district horse show meeting.
3. At the district horse show meeting, counties bring their recommendations to discuss. If the proposed item passes at the district meeting, each district compiles these recommended changes and presents them at the state horse meeting.
4. At the state 4-H horse meeting, each district is allowed three votes. These delegates include the Research and Extension Center head from each district (one vote each), while each district decides the other two voting delegates. (NOTE: These two voting delegates MUST NOT work for Extension.) Each proposed rule and regulation is considered, discussed, and voted upon by the three delegates from each of the four districts. The state 4-H horse show meeting is held in mid- to late September at Mississippi State University in Starkville.
5. The rules and regulations from the state 4-H horse show meeting are then implemented for the following year's show.

Note that a change in a rule can be proposed by another district at the state meeting that your own district had not considered at your meeting.

Respectfully submitted,



Dean Jousan, PhD

Extension 4-H Livestock Specialist

Conformation or In-Hand (Halter) Classes

- 1 Registered Other Breeds mares (no ponies)^a
- 2 Open Miniature mares (38 in and under)^a
- 3 Saddle and Gaited mares^{a,d}
- 4 Pony mares (48 in and under), Jr. 8-13
- 5 Pony mares (over 48-52 in), Jr. 8-13
- 6 Registered Quarter Horse yearling, 2-yr-old and 3-yr-old mares
- 7 Registered Quarter Horse 4-yr-old and older mares
- 8 Registered Quarter Horse broodmares
- 9 Grade Western (over 52 in) mares
- 10 Grade Western (over 52 in) broodmares
- 11 Registered Paint mares^a
- 12 Registered Quarter Horse yearling, 2-yr-old and 3-year-old geldings
- 13 Registered Quarter Horse 4-yr-old and older geldings
- 14 Grade Western (over 52 in) geldings^a
- 15 Registered Paint geldings^a
- 16 Pony geldings (48 in and under), Jr. 8-13
- 17 Pony geldings (over 48-52 in), Jr. 8-13
- 18 Registered Other Breeds geldings (no ponies)^a
- 19 Open Miniature geldings (38 in and under)^a
- 20 Saddle and Gaited geldings^{a,d}

Performance Classes

- 21 Showmanship, Jr. 8-11 (21 and 22 will combine at State)
- 22 Showmanship, Jr. 12-13 (38" and under)
- 23 Showmanship, Sr. 14-15 (23 and 24 will combine at State)
- 24 Showmanship, Sr. 16-18
- 25 Saddle and Gaited Showmanship, Jr. 8-13^d
- 26 Saddle and Gaited Showmanship, Sr. 14-18^d
- 27 Padded Saddle and Gaited Horse Pleasure, show walk/favorite gait, exhibitor 8-18^{b,d}
- 28 Saddle Horse Pleasure (show walk/favorite gait, flat shod), Jr. 8-13^{b,d}
- 29 Saddle Horse Pleasure (show walk/favorite gait, flat shod), Sr. 14-18^{b,d}
- 30 Country Pleasure (flat shod) 8-18^{b,d}
- 31 Racking Horse (flat shod), Jr. 8-13^{b,d}
- 32 Racking Horse (flat shod), Sr. 14-18^{b,d}
- 33 Racking Horse (padded), exhibitor 8-18^{b,d}
- 34 Saddle and Gaited Equitation, Jr. 8-13^{b,d,e}
- 35 Saddle and Gaited Equitation, Sr. 14-18^{b,d,e}
- 36 Saddle and Gaited Trail, exhibitor 8-18^{b,d,e}
- 37 Pony Pleasure (52 in and under) (lope), Jr. 8-13
- 38 Western Pony Walk/Jog, Jr. 8-13^{c,d}
- 39 Western Walk/Jog, exhibitor 8-18^{c,d} (38" and under)
- 40 Western Pleasure, Jr. 8-11 (40 and 41 will combine at State)
- 41 Western Pleasure, Jr. 12-13

- 42 Western Pleasure, Sr. 14-15 (42 and 43 will combine at State)
- 43 Western Pleasure, Sr. 16-18
- 44 Western Riding, exhibitor 8-18
- 45 Western Horsemanship Walk/Jog, exhibitor 8-18^{c,d}
- 46 Western Horsemanship, Jr. 8-13
- 47 Western Horsemanship, Sr. 14-18
- 48 Miniature In Hand Trail, Jr. 8-13^d
- 49 Miniature In Hand Trail, Sr. 14-18^d
- 50 Western Walk/Jog Trail, exhibitor 8-18^{c,d}
- 51 Trail Class, Jr. 8-13
- 52 Trail Class, Sr. 14-18
- 53 Special Needs Walk/Jog Trail, exhibitor 8-18^{c,d}
- 54 Reining, exhibitor 8-18
- 55 Hunter Under Saddle Walk/Trot (Bridle Path Hack), exhibitor 8-18^{c,d}
- 56 Pony Hunter Under Saddle (Bridle Path Hack), (52 in and under) (canter), Jr. 8-13
- 57 Hunter Under Saddle (Bridle Path Hack), Jr. 8-11 (57 and 58 will combine at State)
- 58 Hunter Under Saddle (Bridle Path Hack), Jr. 12-13
- 59 Hunter Under Saddle (Bridle Path Hack), Sr. 14-15 (59 and 60 will combine at State)
- 60 Hunter Under Saddle (Bridle Path Hack), Sr. 16-18
- 61 Hunt Seat Equitation Walk/Trot, exhibitor 8-18^{c,d}
- 62 Hunt Seat Equitation, Jr. 8-13
- 63 Hunt Seat Equitation, Sr. 14-18
- 64 Miniature In Hand Over Fences, Jr. 8-13^d
- 65 Miniature In Hand Over Fences, Sr. 14-18^d
- 66 Cross Rails, exhibitor 8-18^e
- 67 Working Hunter, exhibitor 8-18^e
- 68 Equitation Over Fences, exhibitor 8-18^e
- 69 Jumping, exhibitor 8-18^e
- 70 Introductory Dressage, Walk/Trot (No Canter), exhibitor 8-18^e
- 71 Dressage, Jr. 8-13^e
- 72 Dressage, Sr. 14-18^e
- 73 Pole Bending – Pony (48 in and under), Jr. 8-13
- 74 Pole Bending – Pony (over 48-52 in), Jr. 8-13
- 75 Pole Bending (over 52 in), Jr. 8-11 (75 and 76 will combine at State)
- 76 Pole Bending (over 52 in), Jr. 12-13
- 77 Pole Bending (over 52 in), Sr. 14-15 (77 and 78 will combine at State)
- 78 Pole Bending (over 52 in), Sr. 16-18
- 79 Barrel Racing – Pony (48 in and under), Jr. 8-13
- 80 Barrel Racing – Pony (over 48-52 in), Jr. 8-13
- 81 Barrel Racing (over 52 in), Jr. 8-11 (81 and 82 will combine at State)
- 82 Barrel Racing (over 52 in), Jr. 12-13
- 83 Barrel Racing (over 52 in), Sr. 14-15 (83 and 84 will combine at State)

- 84 Barrel Racing (over 52 in), Sr. 16-18
- 85 Stake Race – Pony (48 in and under), Jr. 8-13
- 86 Stake Race – Pony (over 48-52 in), Jr. 8-13
- 87 Stake Race (over 52 in), Jr. 8-11 (87 and 88 will combine at State)
- 88 Stake Race (over 52 in), Jr. 12-13
- 89 Stake Race (over 52 in), Sr. 14-15 (89 and 90 will combine at State)
- 90 Stake Race (over 52 in), Sr. 16-18
- 91 Calf Roping, Jr. 8-13^{d,f}
- 92 Calf Roping, Sr. 14-18^{d,f}
- 93 Breakaway Roping, Jr. 8-13^{d,f}
- 94 Breakaway Roping, Sr. 14-18^{d,f}
- 95 Working Cow Horse (boxing only), Jr. 8-13^d
- 96 Working Cow Horse (boxing only), Sr. 14-18^d
- 97 Special Needs Walk/Jog Horsemanship, exhibitor 8-18^{c,d}
- 98 Dally Team Roping, exhibitor 8-18^{d,f}
- 99 Ranch Sorting, exhibitor 8-18^d
- 100 Goat Tying, Jr. 8-13^d
- 101 Goat Tying, Sr. 14-18^d
- 102 Ranch Riding, Jr. 8-13^d
- 103 Ranch Riding, Sr. 14-18^d
- 104 Ranch Trail, Jr. 8-13^d
- 105 Ranch Trail, Sr. 14-18^d
- 106 Ranch Ground Handling, Jr. 8-13^d
- 107 Ranch Ground Handling, Sr. 14-18^d
- 108 Ranch Roping, exhibitor 8-18^{d,e}
- 109 Ranch Pleasure, Jr. 8-13^d
- 110 Ranch Pleasure, Sr. 14-18^d

^aThe Grand Champion and Reserve Champion will be the horses/ponies that placed first and second in these classes.

^bIf the horse is flat shod, it can be entered in the following classes: 28 or 29; 30; 31 or 32; 34 or 35; 36. If the horse is shown with pads, it can be entered in the following classes: 27; 33; 34 or 35; and 36.

^cContestants entered in this class may enter only Halter, Showmanship, English/Western Walk/Trot-Walk/Jog, Miniature In Hand, Introductory Dressage, and Special Needs classes, if exhibitor and horse qualify for such classes. Entry in other classes is prohibited.

^dThese classes will be held at the state show only. (May be held at district shows as nonqualifying classes.)

^eThese classes will be held at the state show only.

^fContestant may enter both individual Roping events (Calf Roping or Breakaway) and may enter one team Roping class twice (once as a header and once as a heeler).

- Each exhibitor/horse combination must fill out an entry form.
- Check with your county Extension personnel for entry information.

Mississippi 4-H Horse Clubs, Inc.

State Officers

President

Kim Moss, PO Box 733, Bruce 38915

Vice President

Debbie Hughes, 270 CR 1124, Mooreville 38857

Secretary

Dr. Dean Jousan, Box 9815, Mississippi State 39762

Treasurer

Dr. Dean Jousan, Box 9815, Mississippi State 39762

Directors

NORTHEAST DISTRICT

Lance Newman, PO Box 1690, Verona 38879

Johnny Thompson, 4635 County Lake Road, Starkville 39759

Debbie Hughes, 270 CR 11224, Mooreville 38857

NORTHWEST DISTRICT

Alex Deason, PO Box 197, Stoneville 38776

Kim Moss, PO Box 733, Bruce 38915

Gale Myers, 1244 CR 177, Greenwood 38930

SOUTHEAST DISTRICT

Tawnya Holliman, 952 Sullivan Dr., Hattiesburg 39401

Lynn Strickland, 539 Aunt Jenny Rd., Newton 39345

Haley Vogt, 93 Ellis Odom Rd., Richton 39476

SOUTHWEST DISTRICT

Theresa Hand, PO Box 1207, Raymond 39154

Kelly Holly, 22151 Magnolia Rd., Brandon 39047

Kim Reed, 3050 Indian Mound Trail Rd., Brandon 39042

ADVISORY COUNCIL

The president of the Mississippi 4-H Horse Clubs, Inc., appoints an advisory council (one person per district) that works on challenges facing the 4-H District and State Horse shows. Each member serves a 4-year term. Members of the 2024 Advisory Council include:

Kelley Bates (SE), final year

Glenn Amason (NW), 1 year remaining

District 4-H Horse Shows

Northeast – Houston/Starkville – June 6–8

President

Debbie Hughes, 270 CR 1124, Mooreville 38857

Vice President

Johnny Thompson, 4635 County Lake Road, Starkville 39759

Secretary

Gina Wills, 112 Fairground Circle, New Albany 38652

Show Manager

Cody Mills, 415 Lee Horn Dr., Suite 4, Houston 38851

Northwest – Winona – June 7–8

President

Kim Moss, PO Box 733, Bruce 38915

Vice President

Gale Myers, 1244 CR 177, Greenwood 38930

Secretary

Anna Austin, PO Box 726, Winona 38967

Show Manager

Amy Beth Ware, PO Box 726, Winona 38967

Southeast – Meridian – June 6–7

President

Jerry Odom, 23 Rocking O Lane, Richton 39476

Vice President

Lynn Strickland, 539 Aunt Jenny Rd., Newton 39345

Secretary

Amanda Woods, 1060 Hwy 13 South, Columbia 39429

Treasurer

Amanda Woods, 1060 Hwy 13 South, Columbia 39429

Show Manager

Brad Jones, 214 N. Critz St. Suite A, Wiggins 39577

Southwest – Jackson – June 6–7

President

Kelly Holly, 22151 Magnolia Rd., Brandon 39047

Vice President

Kim Reed, 3050 Indian Mound Trail Rd., Brandon 39042

Secretary

Heather Jennings, 601 Marquette Rd., Brandon 39042

Show Manager

Shelby Bearden, PO Box 789, Hazlehurst 39083

2024 State 4-H Horse Contests and Show Schedule State Fairgrounds – Jackson, Mississippi

Tuesday, June 18

3–6 p.m. Open show office to check in horses

Wednesday, June 19

8 a.m. **Kirk Fordice Equine Center**
Open show office to check in horses

Classes 101, 100: Goat Tying, Sr. and Jr. (Speed events to follow)

Following Goat Tying 73–74, 75, 77: Pole Bending – pony, Jr. and Sr.

79–80, 81, 83: Barrel Racing – pony, Jr. and Sr.

85–86, 87, 89: Stake Race – pony, Jr. and Sr.

Awards presented for speed events.

***Finalize Wednesday regional qualifying entries and fill any remaining regional qualifying slots**

using high-point list from Wednesday’s regional qualifying classes.

Thursday, June 20

8 a.m. **Kirk Fordice Equine Center**
Classes 92, 91: Calf Roping, Sr. and Jr.; Classes 94, 93: Breakaway Roping, Sr. and Jr.; Class 98: Dally Team Roping; and Classes 95–96: Jr. and Sr. Working Cow Horse (boxing only); Class 108 Ranch Roping

noon Deadline for setup of County Stall Decoration/Display Contest in designated stall assigned by show manager

3 p.m. Announcement of Horse Art and Horse Photography winners – east end of Kirk Fordice Equine Center

4 p.m. Opening ceremony, parade of counties, and presentation of Cattle and Goat High Point award

Following opening ceremony Alumni Showmanship class

Immediately following parade Class 99: Ranch Sorting (Ranch Division High Point award presented after this class)

Thursday, June 20

10 a.m. **Multipurpose Building (Horses)/Barn 4**
Class 104: Ranch Trail, Jr. and Class 105: Ranch Trail, Sr., followed by Class 102: Ranch Riding, Jr. and Class 103: Ranch Riding, Sr.: Class 109: Ranch Pleasure, Jr and Class 110: Ranch Pleasure, Sr.

Thursday, June 20

8 a.m. **Rodeo Barn/Barn 11**
Classes 106–107: Jr. and Sr. Ranch Ground Handling

2 p.m. (or immediately Classes 64 and 65: Jr. and Sr. Miniature In Hand Over Fences followed by Classes 48 and 49: Jr. and Sr.

following Ranch Classes) Miniature In Hand Trail

***Finalize Thursday regional qualifying entries and fill any remaining regional qualifying slots**

using high-point list from Thursday’s regional qualifying classes.

Friday, June 21

8 a.m. **Kirk Fordice Equine Center**
Halter classes and Showmanship

Ring 1

1: Registered Other Breeds mares

2: Open Miniature mares (38 inches and under)

3: Saddle and Gaited mares (over 52 inches)

Selection of Champion and Reserve Champion mares (Other Breeds, Miniature, Saddle and Gaited)

4–5: Pony mares, junior 8–13

Selection of Champion and Reserve Champion Pony mares

6–8: Registered American Quarter Horse mares

Selection of Champion and Reserve Champion Quarter Horse mares

9–10: Grade Western mares (over 52 inches)

Selection of Champion and Reserve Champion Grade Western mares

11: Registered Paint mares

Selection of Champion and Reserve Champion mares (Quarter Horse, Registered Paint, Grade Western, and Pony)

21: Showmanship, Jr. 8–13

Ring 2

12–13: Registered American Quarter Horse geldings

Selection of Champion and Reserve Champion Quarter Horse geldings

14: Grade Western geldings (over 52 inches)

15: Registered Paint geldings

16–17: Pony geldings, Jr. 8–13

Selection of Champion and Reserve Champion Pony geldings

Selection of Champion and Reserve Champion geldings (Quarter Horse, Registered Paint, Grade Western, and Pony)

18: Registered Other Breeds geldings

19: Open Miniature geldings (38 in and under)

20: Saddle and Gaited geldings (over 52 inches)

Selection of Champion and Reserve Champion geldings (Other Breeds, Miniature, Saddle and Gaited)

25: Saddle and Gaited Showmanship, Jr. 8–13

26: Saddle and Gaited Showmanship, Sr. 14–18

23: Showmanship, Sr. 14–18

Performance Classes

27: Padded Saddle and Gaited Horse, show walk/favorite gait, exhibitor 8-18

28–29: Saddle Horse Pleasure (show walk/favorite gait, flat shod), Jr. and Sr.

31–32: Racking Horse (flat shod), Jr. and Sr.

33: Racking Horse (padded), exhibitor 8-18

34–35: Saddle and Gaited Equitation, Jr. and Sr.

30: Country Pleasure (flat shod), exhibitor 8-18

37: Pony Pleasure (52 inches and under) (canter), Jr. 8–13

38: Western Pony Walk/Jog Pleasure, Jr. 8–13

39: Western Walk/Jog Pleasure, Jr. and Sr.

40, 42: Western Pleasure, Jr. and Sr.

45: Western Horsemanship Walk/Jog, exhibitor 8-18

46–47: Western Horsemanship, Jr. and Sr.

44: Western Riding, exhibitor 8–18

54: Reining, exhibitor 8–18

Friday, June 21

10 a.m.

Rodeo Barn/Barn 11

Class 53: Special Needs Walk/Jog Trail class, exhibitor 8–18

Class 97: Special Needs Walk/Jog Horsemanship class, exhibitor 8–18

Special Needs Walk/Jog Trail will be open from 10 until 11 a.m.

noon (or following

Showmanship classes)

50: Western Walk/Jog Trail, exhibitor 8-18

51–52: Trail, Jr. and Sr.

Classes 50–52 will run concurrently for 3 hours once the course opens

Class 36: Saddle and Gaited Trail, exhibitor 8–18, will open 15 minutes after Western Trail and be open for 2 hours

Awards presented for all remaining divisions except Pony and Hunter.

***Finalize Friday regional qualifying entries and fill any remaining regional qualifying slots**

using high-point list from Friday's regional qualifying classes.

***At the conclusion of the show on Friday night, a list of high-point horses that includes juniors and seniors will be used to fill the High Point and Second High Point Horse from Friday (not already qualified) slots. Points earned on a single horse will be calculated for Halter, Showmanship, Western Pleasure, Western Riding, Western Horsemanship, Trail, Reining, Padded Saddle and Gaited Horse Pleasure, Saddle Horse Pleasure, Racking Horse, Saddle and Gaited Equitation, and Saddle and Gaited Trail.**

| | |
|--------------------------|---|
| Saturday, June 22 | Kirk Fordice Equine Center |
| 7 a.m. | Open show office to check in horses |
| 8-9 a.m. | Measure ponies to school for Over Fences Classes – report to Show Office to get pony measured |
| 9-10:30 a.m. | Schooling for Over Fences Classes – report to paddock area for schooling time |
| 11 a.m. | Classes 66-69: Cross Rails, Working Hunter, Equitation Over Fences, and Jumping (all ponies must be measured before being allowed to show in Over Fences classes) |
| After Over Fences | Classes 56, 55, 57, 59: Hunter Under Saddle, Pony, Walk/Trot, Jr. and Sr.; classes 61-63: Hunt Seat Equitation, Walk/Trot, Hunt Seat Equitation, Jr. and Sr. High Point Hunter division award presented at end of Saturday's classes. |

| | |
|--------------------------|---|
| Saturday, June 22 | Multipurpose Building (Horses)/Barn 4 |
| 8 a.m. | Class 70: Introductory Dressage Walk/Trot (no canter), Classes 71-72: Dressage, Jr. and Sr. Introductory Dressage Walk/Trot (no canter) and Jr. and Sr. Dressage riders will be assigned ride time |

Awards presented at end of show:

High-point horses, exhibitors, pony, hunter, counties, county educational display, and Swazye Woodruff Memorial All-Around Award

***Finalize Saturday regional qualifying entries and fill any remaining regional qualifying slots using high-point list from Saturday's regional qualifying classes.**

***At the conclusion of the show on Saturday night, a list of high-point horses that includes juniors and seniors for all regional qualifying classes during the State 4-H Horse Championships will be made. This list will be used to fill any vacancies for the Southern Regional Horse Show that were not filled from the shows on Wednesday, Thursday, Friday, or Saturday nights.**

***Exhibitors with horses qualifying on Wednesday, Thursday, Friday, and Saturday must pay the regional entry fee within 30 minutes after the last qualifying class each day or forfeit the right to go to the regional show.**

NOTE: Explanation of regional qualifying slots filled from Conformation or In-Hand (Halter) classes (four horses will qualify for the regional show) is as follows:

- Champion mare (Other Breeds, Miniature, Saddle and Gaited) will be selected from the Champion Registered Other Breeds, Champion Open Miniature, and Champion Saddle and Gaited mares.
- Champion mare (Quarter Horse, Registered Paint, Grade Western, Pony) will be selected from the Champion Quarter Horse, Champion Registered Paint, Champion Grade Western, and Champion Pony mares.
- Champion gelding (Other Breeds, Miniature, Saddle and Gaited) will be selected from the Champion Registered Other Breeds, Champion Open Miniature, and Champion Saddle and Gaited geldings.
- Champion gelding (Quarter Horse, Registered Paint, Grade Western, Pony) will be selected from the Champion Quarter Horse, Champion Registered Paint, Champion Grade Western, and Champion Pony geldings.
- The second-place horse or Reserve Champion horse in the class or breed division from which the Champion mare and gelding (Other Breeds, Miniature, Saddle and Gaited) and the Champion mare and gelding (Quarter Horse, Registered Paint, Grade Western, Pony) have been selected, respectively, will be placed in line with the other first-place or Champion winners to be judged for the Reserve Champion mare and gelding (Other Breeds, Miniature, Saddle and Gaited) and the Reserve Champion mare and gelding (Quarter Horse, Registered Paint, Grade Western, Pony). The Reserve Champion mare and gelding (Other Breeds, Miniature, Saddle and Gaited) and the Reserve Champion mare and gelding (Quarter Horse, Registered Paint, Grade Western, Pony) will be the alternate to qualify for the regional qualifying slots.

Regional Qualifying Slots (70)

Ring One Champion Mare (Other Breeds, Miniature, Saddle and Gaited)

Ring One Champion Mare (Quarter Horse, Registered Paint, Grade Western, Pony)

Ring Two Champion Gelding (Other Breeds, Miniature, Saddle and Gaited)

Ring Two Champion Gelding (Quarter Horse, Registered Paint, Grade Western, Pony)

Working Hunter (Best Score)

Equitation Over Fences (Best Score)

Jumping, exhibitor 8-18

Jr. Hunter Under Saddle

Sr. Hunter Under Saddle

Jr. Hunt Seat Equitation (Best Score)

Sr. Hunt Seat Equitation (Best Score)

Jr. and Sr. Dressage (Best Score)

Jr. and Sr. Breakaway Roping (Fastest Time)

Jr. Ranch Riding (Best Score)

Sr. Ranch Riding (Best Score)

Ranch Roping (Best Score)

Jr. Ranch Trail (Best Score)

Sr. Ranch Trail (Best Score)

Jr. and Sr. Working Cow Horse (boxing only) (Best Score)

Jr. Ground Handling (Best Score)

Sr. Ground Handling (Best Score)

Jr. Showmanship (Best Score)

Sr. Showmanship (Best Score)

Jr. Trail (Best Score)

Sr. Trail (Best Score)

Jr. Western Pleasure

Sr. Western Pleasure

Jr. Horsemanship (Best Score)

Sr. Horsemanship (Best Score)

Western Riding, exhibitor 8-18 (Best Score)

Jr. and Sr. Reining (Best Score)

Pony & Jr. Pole Bending (Fastest Time)

Sr. Pole Bending (Fastest Time)

Pole Bending (Fastest Time not Qualified)

Pole Bending (Second Fastest Time not Qualified)

Pole Bending (Third Fastest Time not Qualified)

Pole Bending (Fourth Fastest Time not Qualified)

Pony & Jr. Barrel Racing (Fastest Time)

Sr. Barrel Racing (Fastest Time)

Barrel Racing (Fastest Time not Qualified)

Barrel Racing (Second Fastest Time not Qualified)

Barrel Racing (Third Fastest Time not Qualified)

Barrel Racing (Fourth Fastest Time not Qualified)

Pony & Jr. Stake Race (Fastest Time)

Sr. Stake Race (Fastest Time)

Stake Race (Fastest Time not Qualified)

Stake Race (Second Fastest Time not Qualified)

Stake Race (Third Fastest Time not Qualified)

Stake Race (Fourth Fastest Time not Qualified)

High Point Saddle & Gaited Horse¹

Reserve High Point Saddle & Gaited Horse¹

Third High Point Saddle & Gaited Horse¹

Fourth High Point Saddle & Gaited Horse¹

High Point and 2nd High Point Horses from Saturday (Not Already Qualified)²

High Point, 2nd High Point, 3rd High Point, and 4th High Point Horses from Thursday (Not Already Qualified)³

High Point, 2nd High Point, 3rd High Point, 4th High Point, and 5th High Point Horses from Friday (Not Already Qualified)⁴

High Point, 2nd High Point, 3rd High Point, 4th High Point, 5th High Point, and 6th High Point Horses from Wednesday (Not Already Qualified)⁵

Vacant regional qualifying slots in addition to five alternate regional qualifying slots will be filled after the 70 slots have been taken in case there is a cancellation prior to the entry deadline. The alternate slots will be filled from All Qualifying Classes (Not Already Qualified)⁶

¹High Point, Reserve High Point, Third and Fourth High Point Saddle and Gaited Horses will include points earned in these classes on a single horse: Saddle and Gaited Mares, Saddle and Gaited Geldings, Saddle and Gaited Showmanship, Padded Saddle and Gaited Horse Pleasure, Saddle Horse Pleasure, Racking Horse, Saddle and Gaited Equitation, and Saddle and Gaited Trail.

²High Point and 2nd High Point Horses from Saturday (not already qualified) will include points earned in Hunter Under Saddle, Hunt Seat Equitation, Working Hunter, Equitation Over Fences, Jumping, and Dressage earned on a single horse.

³High Point, 2nd High Point, 3rd High Point, and 4th High Point Horses from Thursday (not already qualified) will include points earned in Breakaway Roping, Ground Handling, Ranch Roping, Working Cow Horse (boxing only), Ranch Riding, and Ranch Trail earned on a single horse.

⁴High Point, 2nd High Point, 3rd High Point, 4th High Point, and 5th High Point Horses from Friday (not already qualified) will include points earned in Halter, Showmanship, Western Pleasure, Western Riding, Western Horsemanship, Trail, Reining, Padded Saddle and Gaited Horse Pleasure, Saddle Horse Pleasure, Racking Horse, Saddle and Gaited Equitation, and Saddle and Gaited Trail earned on a single horse.

⁵High Point, 2nd High Point, 3rd High Point, 4th High Point, 5th High Point, and 6th High Point Horses from Wednesday (not already qualified) will include points earned in Pole Bending, Stake Race, and Barrel Racing on a single horse.

⁶Vacant and alternate regional qualifying slots will be filled based on the accumulation of points earned for all qualifying classes held during the show on a single horse.

NOTE: Ties for high point horse regional qualifying slots and for filling open slots with high point horses from each day or at the end of the show will be broken in this order: the exhibitor who 1) beats the greatest number of horses in all classes on a single horse; 2) earned the most points in the greatest number of classes on a single horse; or 3) earned the most points in performance classes on a single horse.

****HELMET POLICY FOR EXHIBITORS AT THE SOUTHERN REGIONAL 4-H HORSE CHAMPIONSHIP****

Any youth age 18 or under (as of January 1 of the current show year) is required to wear a properly fastened American Standard for Testing Materials (ASTM)/Safety Equipment Institutes (SEI) approved protective headgear when mounted on a horse. Helmet use is required when mounted AT ALL TIMES on the show grounds, including all performance classes and divisions. Additionally, this policy is in effect in the show pen as well as ALL warm-up/practice pens and on the show grounds when mounted. Violation of this policy may result in disqualification from the show and/or removal from show grounds.

It is the responsibility of the exhibitor, or the parent, guardian, or trainer of the exhibitor, to ensure the headgear worn complies with appropriate safety standards for protective headgear intended for equestrians' use and is properly fitted and in good condition. The Southern Regional Show Committee and officials are not responsible for checking appropriateness of headgear worn.

**The Southern Regional Show Committee and officials make no representation or warranty, expressed or implied, about any protective headgear, and cautions riders that death or serious injury may result despite wearing such headgear because all equestrian sports involve inherently dangerous risks, and no helmet can protect against all foreseeable injuries.*

General 4-H Regulations

1. 4-H'ers showing or planning to show in the district and state 4-H horse shows must be 4-H members by May 1 of the current year.
2. 4-H'ers and at least one parent/guardian who are planning to show in the district or state 4-H horse show must complete an ethics certification program by June 1 of the current year. In addition, any volunteer who plans to assist any exhibitor at any 4-H horse show must complete the ethics certification program by June 1 of the current year.
3. Each and all horses/equids exhibited in any 4-H show must be solely owned by the 4-H'er showing the horse or by an immediate family member by May 1. (Note: The term "horse" will be used hereafter to include all equids.) Mississippi 4-H Horse Clubs, Inc., defines an immediate family member as a parent, stepparent, brother, sister, half brother, half sister, step-sibling, grandparent, step-grandparent, or legal guardian. Legal guardianship is determined by presenting an official court order (authorized by a judge) before the show. (Horses registered in the name of a farm are not eligible.) A lease horse may be shown in any 4-H show where a signed affidavit by the current owner, exhibitor(s), exhibitor's parents or guardian, and Extension agent can attest to the fact that the exhibitor has ownership of the horse for the purpose of showing at any District, State, or Southern Regional 4-H Horse Championships for the dates recorded on the affidavit. All possession, housing and care, and horse show rules contained within the Mississippi 4-H Horse Show Classes, Rules, and Regulations (P821) apply to the exhibitor/leased horse. A copy of the affidavit and registration certificate must be sent with entry forms for any 4-H horse show by the ownership/entry deadline. Accredited residential childcare facilities may gain approval from the 4-H Horse Advisory Council so their youth can participate in the Mississippi 4-H horse shows. In this situation, horses must be owned by the facility and all rules in this rule book must be followed by these youth. The facility must provide documentation that the child is enrolled in the school and horse ownership papers must be in the facility's name. In addition, registered horses will be registered with the proper registry association by May 1 of the show year. Exhibitors are expected to own, maintain/care for, and work/ride their own horses from May 1 to show date.
4. All exhibitors must be active and current members of Mississippi 4-H. 4-H age is 8-18 and is determined by the exhibitor's age on January 1 of the current show year.
5. A horse owned jointly by a 4-H member and an adult (anyone 19 years or older), other than those listed in rule 3, or a horse owned by two or more 4-H members not of the same family, is not eligible to show.
6. A county Extension agent must certify, to the best of his or her knowledge, the eligibility of the 4-H member in meeting all 4-H district and state show requirements, and ownership, age, sex, and registration status of each horse. Entry forms used for 4-H shows provide space for all information necessary for entering district and state shows.
7. Each district will elect a rules committee to be composed of the following people:
 - a. Elected position (Extension or non-Extension personnel)
 - b. Show manager/secretary
 - c. Elected position (non-Extension personnel)
 - d. Elected position (non-Extension personnel)
 - e. Elected position (non-Extension personnel)
 - f. Elected alternate (non-Extension personnel)
 - g. Elected alternate (non-Extension personnel)The rules committee will have five people present at all times during the show. Each district may elect as many alternates as necessary to fill the positions. The rules committee will serve as an advisory committee for the show manager/secretary before and during the show. In addition, the rules committee will convene and rule on any protest that is filed concerning the district 4-H horse show.
8. The rules committee for the state 4-H horse show will be composed of the following people:
 - a. Extension 4-H livestock specialist (committee chair; will vote only in case of a tie)
 - b. President or vice president of Mississippi 4-H Horse Clubs, Inc.
 - c. Elected northeast district member or elected alternate
 - d. Elected northwest district member or elected alternate
 - e. Elected southwest district member or elected alternate
 - f. Elected southeast district member or elected alternateEach district member and alternate will be a member of the rules committee in his/her respective district. The rules committee will serve as an advisory committee for the 4-H livestock specialist

before and during the show. In addition, the rules committee will convene and rule on any protest that is filed concerning the State 4-H Horse Show. The Extension 4-H Livestock Specialist will serve as chair and will serve as the liaison between interested parties and the rules committee. The committee chair will vote on issues only in the event of a tie vote.

9. Each district will have an equipment judge for each of the district shows. In addition, an equipment judge will be hired for the state show. At the state show only, the equipment judges will serve as "official judges"; therefore, their decisions are final and cannot be protested under any circumstances. The role of the equipment judge will be that of an educator. He or she will check equipment and attire prior to the classes and if illegal equipment or attire is presented, explain to the exhibitor and/or parent why it must be changed and allow them a reasonable opportunity to change the equipment or attire. Participants exhibiting with illegal appointments will be disqualified at the discretion of the judge.

General Show Rules and Regulations

1. The management of 4-H horse shows is not responsible for any accident or injury to any participant, animal, or spectator entered in or at shows.
2. A horse is not eligible for the 4-H shows (district, state, regionals) if that horse has been shown or ridden in competition in any other show after May 1 by an adult (person 19 or over) unless that adult is a member of the immediate family (see definition in rule 3 under General 4-H Regulations). The rules committee must approve legal guardianship before May 1. The 4-H youth agent or 4-H leader must submit this to the rules committee.
3. Original certificate or official ownership form for registered, leased, or grade horses must accompany each horse showing in the district and state 4-H shows. Such certificate or form must be presented to the entry clerk upon arrival to establish eligibility for showing. Papers must be in ownership name or names as listed in rule 3 under General 4-H Regulations. Papers must be maintained with horse for duration of show.
4. No entries will be accepted and no refunds will be made after the entry deadlines for district and state shows. District show management will notify Extension agents of the entry deadline for their respective district shows. Copy of ownership form for grade horses and/or copy of registration papers for registered horses must be sent in with entry forms by district show entry deadline.
5. American Quarter Horse, Appaloosa, Paint, and Registered Arabian horses must be registered in the proper registry association. If enough interest is shown in another breed not listed, the breed classification may be added the following year, provided 10 or more are shown at all district shows. Registered horses of other breeds (other than ponies and saddle and gaited horses) must show in the Other Breeds classification. Registered horses that are also registered in the American Quarter Horse Association must show in the Quarter Horse halter classes (example: a horse registered in the Palomino or Buckskin Registry and American Quarter Horse Association must show in the American Quarter Horse halter classes).
6. Halter classes will be judged separately by breed as designated by Mississippi 4-H Horse Clubs, Inc. All breeds compete together in performance classes.
7. For determining age of horses for all classes, the classification will be computed by the calendar year, starting on January 1 of the year foaled. A horse is a weanling during the calendar year in which it is foaled and a yearling during the first year following its foaling date. For example, a horse foaled any time during 2014 is considered a yearling on January 1, 2015, and a 2-year-old on January 1, 2016.
8. An exhibitor may enter only one horse per class in Conformation or In-Hand (Halter) classes. Also, an exhibitor may enter only one horse per class in performance classes. The only exception is Team Roping, when an exhibitor may enter Team Roping twice—only one time as a header and only one time as a heeler (can be different teams) and may ride the same or a different horse as a heeler.
9. A horse owned jointly by two or more 4-H members of the same family may be entered in one performance class by one owner and in another class by the other owner. No horse is allowed to enter the same type of performance class twice (junior or senior). For example: One joint owner may ride the horse in pole bending and the other owner may ride the same horse in barrel racing, but they cannot both ride the same horse in the pole bending or barrel racing class. The only exception is if a jointly owned horse is being shown in an introductory class. For example, one sibling may ride a horse in Western Walk/Jog and another sibling may ride the same horse in Western Pleasure.
10. The same horse and exhibitor must show at the state show that showed in the district show. Exhibitors must personally show their individual horses in district and state shows (no exceptions).
11. Official judges' decisions are final and cannot be protested under any circumstances. Show management has the right to make clerical corrections to placings within 30 minutes after the end of the show each day.
12. The rules committee will rule on situations not covered in this handbook or questions regarding conduct of the show, and their decisions will be final.
13. Rules and regulations in this handbook are intended to establish uniform policies and procedures for District and State 4-H Horse Shows in Mississippi.
14. The equipment judge or rules committee will pass on the qualifications of exhibitors and exhibits. The judge and equipment judge may consult with each other regarding any possible illegal equipment and/or attire.
15. The judge, show management, or rules committee will have the authority to rule out or dismiss any horse that is considered improperly trained to be safely controlled. The judge may disqualify any contestant for excessive use of a whip, rope, crop, bat, or reins anywhere on the horse. Exhibitor or exhibitor's parents, guardian, leader, or agent must display good sportsmanship, including humane treatment of horses on the premises, and are expected to honor the 4-H Code of Conduct at all times. Any discourtesy toward Mississippi 4-H Horse Show officials, other exhibitors, parents, guardians, leaders, agents, or spectators may result in forfeiture of awards and/or dismissal from the show. Violations may result in the State 4-H office's banning an exhibitor from competing in future 4-H shows. Falsifying records (registration/grade papers, Coggins test, entry forms, etc.) will result in forfeiture of awards and/or dismissal

from the show. Such violations may result in being put on probation and in the state 4-H office's banning an exhibitor and/or exhibitor's parents or guardian from competing in future 4-H horse shows.

16. Horses must enter the arena gate (starting line) and begin performance within 1 minute of being called by the arena announcer. No assistance is allowed beyond the starting line.
17. No one other than the exhibitors, judge, ringmaster, safety committee members, and show management officials can come into the ring while any class is being judged. The only exception to this rule is in the Roping Division when a contestant is allowed to have one person to help secure their horse in the box. Refer to the General Rules and Regulations in the Roping Division section for more information.
18. The judge or equipment judge shall have the authority to require the removal or alteration of any piece of equipment or apparatus that gives a horse an unfair advantage or is unsafe or inhumane. Inhumane treatment of a horse at any time on any location on the show grounds may result in disqualification of the contestant. The standard by which conduct or treatment will be measured is that which a reasonable person informed or experienced in generally accepted equine training and exhibition procedures would determine to be cruel, abusive, or inhumane. Judge or bit judge should disqualify from performance a horse that is observed with blood on its body, including, but not limited to, the nose, chin, mouth, tongue, or gums, regardless of cause.
19. In speed events, an electric timer will be used. However, in the cattle and goat tying events, two stopwatches (simultaneously) may be used for timing these events. When using stopwatches to time an event, the same timekeepers (same individuals) will be used for the entirety of each class. There will be designated an official and a backup timekeeper. The official time will be used on every run, and the backup time will be used only when there is a malfunction in the official time.
20. If a correct pattern is run and the timer fails to record a rider's time, the contestant will be allowed to rerun the pattern.
21. In the event of a tie, the horse declared the winner in the runoff must run the pattern within 2 seconds of its original time, or the runoff must be held again. All ties will be broken by a flip of the coin with the exception of first, second, and third, and the final state show qualifying slot at the district show.
22. Whenever this handbook refers to "hackamore," it will mean that the horse will be ridden ONLY with a rawhide braided, leather braided, or rope bosal. Absolutely no iron will be permitted under the jaws, regardless of how padded or taped. This definition applies to performance events, excluding showmanship. No bare metal will be allowed on the horse's head (curb chains excluded, but chain must meet minimum size requirements). See particular class for more information.
23. Protests must be submitted to the announcer or manager of the show. Protests must be made on an official protest form properly filled out, signed, and accompanied by a \$150 cash deposit. This protest must designate the exhibitor or animal involved and the reason for the protest being filed. Protest must be made before official placing of the class involved is announced. No protest will be accepted on a class after the official results have been announced. Protests are made with the understanding that the

protestor's name will be made public and that if the protest is not upheld by the rules committee, the \$150 cash deposit will be the property of the Mississippi 4-H Horse Clubs, Inc. If the protest is upheld, the \$150 cash deposit will be returned to the person filing the protest. Protest forms will be available at the announcer's stand.

24. Exhibitor's number will be worn in the appropriate location according to the discipline listed in the table below. Please note that if the event requires numbers to be worn on both sides of the saddle pad then two numbers are needed, one for each side. Failure by exhibitor to wear correct number(s) in a visible manner shall result in disqualification.

| Number placement | Class |
|-------------------------|---------------------------|
| Saddle pad (both sides) | Western |
| | Ranch |
| | English |
| | Saddle and Gaited-Western |
| Exhibitor's back | Saddle and Gaited-English |
| | Halter |
| Optional | Roping and Speed |
| | Jumping and Over-fence |
| | Dressage |

25. No weanlings (refers to a horse during the calendar year in which it is foaled) or stallions are eligible to show in Mississippi 4-H horse shows.

26. District-Only Substitution Rule

If an exhibitor has two or more horses entered in the district show or a state-only class, and one of those horses is unable to be shown at district because of injury, sickness, or death, the exhibitor may substitute **only** one of the other horses entered for the horse that is unable to be shown. A substituted horse may show in the classes in which it was entered and in the same classes that the horse that is unable to show had entered if applicable. A horse can only be substituted at the district show, not at the state show (except for state-only classes). In order to make a substitution, the exhibitor must have a written statement from a veterinarian stating that the horse is unable to show and the reason that the horse is unable to show. This written statement must be on the veterinarian's letterhead. Once a horse substitution letter is given to the show office, it becomes the property of show management and that horse is ineligible to show at that year's district and state horse shows. A substitution must be made at least three classes before the class in which the substituted horse will show. If the substitution is for a horse in one of the first three classes of the day, the substitution must be made at least 30 minutes before the start of the show that day.

State-Only Class Substitution Rule (3, 20, 25-36, 38-39, 45, 48-50, 53, 55, 61, 64-72, 95-97, 99, 102-110)

NOTE: State-only class numbers change as classes are added and dropped from the program each year. You are responsible for checking these class numbers. If an exhibitor has a horse entered in a state-only class and this horse is unable to show because of injury, sickness, or death, the exhibitor may substitute only one

of his/her horses that is entered in the district show or entered in a state-only class. A substituted horse may show only in the state-only classes that the injured horse was entered. In order to make a substitution, the exhibitor must have a written statement from a veterinarian stating that the horse is unable to show and the reason that the horse is unable to show. This written statement must be on the veterinarian's letterhead. Once a horse substitution letter is given to the show office, it becomes the property of show management and that horse is ineligible to show at that year's state horse show. A substitution must be made at least three classes before the class in which the substituted horse will show. If the substitution is for a horse in one of the first three classes of the day, the substitution must be made at least 30 minutes before the start of the show that day.

27. All horses must meet the health requirements set forth by the Mississippi Board of Animal Health. All horses brought onto the show grounds must be accompanied by an Original Negative Equine Infectious Anemia Test Certification or certified Coggins document (PHOTOCOPIES WILL NOT BE ACCEPTED) in hand bearing lab number with animal identification issued within 12 months of the show date.
28. All horses and ponies ridden in Mississippi 4-H horse shows must be ridden with saddles.
29. A horse may be shown in only one halter class.
30. To show in broodmare class, the mare must have produced a foal during her lifetime.
31. A horse can show in only one pleasure class. Hunter Under Saddle and Racking are performance classes and not pleasure classes; therefore, the same horse may ride Hunter Under Saddle and Western Pleasure.
32. A 4-H'er requiring a medically necessary safety device will be allowed to show, with approval by the rules committee before the show. No communication devices are allowed unless it is needed for medical reasons. The 4-H'er must provide medical documentation (special needs form) stating the need for said equipment. The rules committee will inform the equipment judge of such situations.
33. No dogs are allowed in the show arena and/or buildings during the district and state shows. Dogs outside of the arena and/or buildings must be on leashes and in control of adult owners.
34. **All youth age 18 or under as of January 1 of the current show year are required to wear properly fastened American Standard for Testing Materials (ASTM)/Safety Equipment Institutes (SEI)-approved protective headgear when mounted on a horse. Helmet use is required when mounted AT ALL TIMES on the show grounds, including all performance classes and divisions. Additionally, this policy is in effect in the show pen as well as ALL warm-up/practice pens and on the show grounds when mounted. Helmets must be properly fitted with a chin harness at all times while riding. Violation of this policy may result in disqualification from the show and/or removal from show grounds.**

It is the responsibility of the youth, or the parent or guardian or trainer of the youth, to ensure that the headgear worn complies with appropriate safety standards for protective headgear

intended for equestrians' use and is properly fitted and in good condition. The State Show Committee and officials are not responsible for checking appropriateness of headgear worn.

35. Only junior 4-H'ers (8-13) are allowed to show ponies in halter and performance classes.
36. In consideration for humane treatment of the horse, the judge, at his or her discretion, has the authority to excuse from a class any horse that is obviously lame.
37. It is the responsibility of exhibitors to know when they must be in the makeup area or arena. Not hearing or understanding class calls, etc., is not an excuse for missing one's order of work, heat, or class. The PA system is used to help the show move as smoothly as possible, but it is only a courtesy.
38. All heats and all working orders will be drawn at random. Working order will be in the official program or posted ahead of the class. In classes with drawn working orders, horses will work in that order or forfeit their right to compete in that class. The show management reserves the right to change the working orders or class schedules if extenuating circumstances warrant.
39. No scooters, roller skates, roller blades, skate boards, bicycles, or motorized scooters will be allowed in the barns, except for equipment for the handicapped.
40. No horses are allowed to be lunged in the main arena of the Kirk Fordice Equine Center.
41. The frequency of dragging the arena shall be left to show management.
42. All patterns will be released no less than 1 week in advance of both the district and state shows.

Rules and regulations published here are effective for the current year's Mississippi 4-H district and state horse shows except as superseded by show management or the horse advisory council as needed. If such a situation arises, the rule modification will be made available to all counties as soon as possible.

State Show Entry Qualifications

1. Only qualifying entries from each of the district 4-H horse shows are eligible. The responsible agent or 4-H youth agent should mail the state-only entries for classes 15-16, 25-36, 38-39, 45, 48-50, 53, 55, 61, 64-72, 95-97, 99, 102-110 and their entry fees directly to Animal and Dairy Sciences, Attn: Dean Jousan, Box 9815, Mississippi State, MS 39762 by May 1 of the current year. NOTE: State-only class numbers change as classes are added and dropped from the program each year. You are responsible for checking these class numbers.
2. The number of horses eligible for the state show varies from class to class and from district to district. This number is based on the number of horses shown in class (not the number of entries). For example, if 15 horses are shown in the Junior Western Pleasure class, then the first 8 horses are eligible to enter the state show, provided they pay their entry fees and are otherwise qualified. The following table shows the number of horses eligible, based on the number of horses shown:

System for Qualifying Horses from District to State

| Number in Class | Number Qualified for State |
|-----------------|----------------------------|
| 1-5 | 4 |
| 6-8 | 5 |
| 9-11 | 6 |
| 12-14 | 7 |
| 15-19 | 8 |
| 20-24 | 9 |
| 25-29 | 10 |
| 30-34 | 11 |
| 35-39 | 12 |
| 40+ | 13 |

- All horses qualifying for the state horse show must enter and pay all fees within 30 minutes of the conclusion of the last state qualifying class of each day. Any exhibitor who does not pay their entry fees within 30 minutes of the last qualifying class each day will forfeit the right to compete at the state horse show in the class or classes that they qualified in that day. Alternates to fill open slots will begin immediately following the 30-minute time limit and will continue for an additional 30 minutes. Books are closed each day at the district horse show. No substitutions or additions will be made after the district show books have been closed. It is the exhibitor’s responsibility to see that all entries and fees are properly made and paid at the appropriate time.
- No horses are allowed on state fairgrounds before 3 p.m. on Tuesday, June 18, 2024.
- Financing State 4-H Horse Show
 - \$10 entry fee (must be paid at conclusion of each district show)
 - \$15 stock charge per individual goat tying
 - \$15 cattle charge per individual roper
 - \$25 working cow horse (boxing only) charge (per individual)
 - \$15 ranch sorting cattle charge (per individual; team charge, \$30)
 - \$20 stall fee (must be paid at conclusion of each district show)
 - \$5 office fee charge per exhibitor. This will provide a program/pattern book to each exhibitor. Additional program books will be available for an additional \$5 each.
 - *Management has the right and authority to move any horses stalled in the incorrect stall.
 - \$212.50 (per district)
- All miniature horses and ponies will be measured at each district show to determine classification. Ponies and miniature horses will be measured only once. No re-measurements will be allowed, and no protests will be allowed by exhibitors on measurements of their ponies or miniature horses. Also, once a pony has been measured, competed at a district show, and qualified for the state horse show, that pony may not be protested at the state horse show regarding its height and will not be measured again at the state horse show. Ponies and miniature horses must be shown as measured (that is, ponies and miniature horses measured without shoes must be shown without shoes). Pony and horse classifications for non-Over Fences classes include the following:

- a. Miniature horse – 38 inches and under
- b. Pony – 48 inches and under
- c. Pony – Over 48-52 inches

If a registered miniature horse measures over 38 inches, it will be moved to the appropriate Registered Other Breeds halter class (Class 11 or 12). If a grade miniature horse measures over 38 inches, it will be moved to the appropriate pony halter class (Classes 17–20).

- At the state horse show, exhibitors with ponies entered in Over Fences classes who intend to participate in the schooling session must report to the show office with their pony between 8 a.m. and 9 a.m. on Saturday, June 24, to get their pony measured to make sure the pony is shown in the correct Over Fences class. All ponies must be measured before competing in the Over Fences classes. Ponies will be measured only once. No re-measurements will be allowed, and no protests will be allowed by exhibitors on measurements of their ponies. Ponies must be shown as measured (that is, ponies measured without shoes must be shown without shoes). Pony height classifications for Over Fences classes are as follows:
 - Small/medium ponies – 13 and under hands
 - Large ponies – over 13 to 14.2 hands
 - Hunter horses – over 14.2 hands
- Miniature horses will be measured only once. No re-measurements will be allowed, and no protests will be allowed by exhibitors on measurements of their miniature horses. Miniature horses must be shown as measured (that is, miniature horses measured without shoes must be shown without shoes). Miniature horses must measure 38 inches and under to be eligible to show in performance classes.

How to Measure Ponies

Stand the animal on a smooth, level surface, in such position that the front legs are vertical and the backs of the hocks are in a vertical line with the point of the horse’s quarter. The head is to be held low enough to reveal the highest point of the withers and no lower. With the horse in this position, measure the vertical distance from the highest point of the withers to the ground. The arm of the measuring standard should be placed over the highest point of the withers, and no measurement taken at any other part of the horse’s body will count. The standard must be a straight, still, unbendable stick, and should be provided with a plumb or spirit level to make sure the standard is perpendicular from withers to the ground and that the cross piece is parallel with the ground surface.

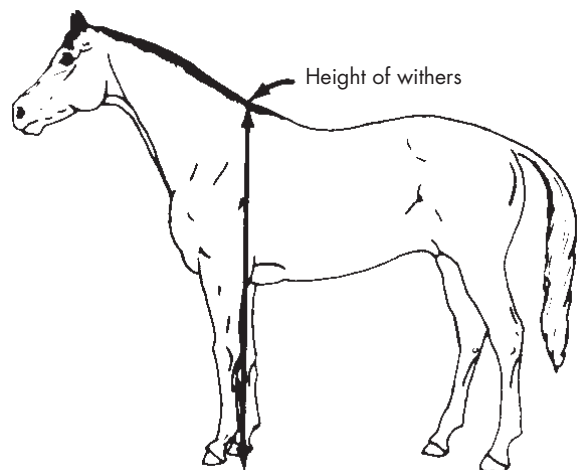

Criteria for Conformation or In-Hand (Halter) Classes 1–20

1. Exhibitors' attire must conform to the requirements of their respective divisions (refer to Western, Hunter, or Saddle/Gaited divisions). Example: If exhibitor is in Western attire, then hats and boots are required. Hats would be optional in Saddle/Gaited, Arabian, and nonstock-type Other Breeds.
2. Horses are judged on conformation, condition, heritable defects, soundness, and way of going at judge's discretion.
3. Horses are judged individually standing, at a walk, and at trot or favorite gait.
4. Horses may be shown in halters made of leather, rope, or other suitable material.
5. Whips or bats of any type are not permitted in conformation classes. Lip chains and cords are prohibited.
6. Horses will be handled and shown by one club member only.
7. Horses should enter the ring as specified by the official. Exhibitors will enter at a walk, proceeding straight to the judge. The judge will move to the exhibitor's left and, at this time, the exhibitor will trot their horse past the judge. Continuing at a trot, the exhibitor will make a 90-degree turn to the left at the designated cone and continue to line-up. Subsequent procedures will be as directed by the judge and/or ring steward.
8. When the top 12 horses are placed, the ring steward will line them up in order of placing so that the public may see how the horses are placed.
9. Horses can be entered and shown in only one conformation or in-hand (halter) class.

Criteria for Showmanship Classes 21–26, 106–107

****Rule:** A horse/exhibitor combination may participate in only one showmanship class (class 21-24 based on exhibitor's age, class 25-26 for saddle/gaited horses based on exhibitor's age, or class 106-107 for ranch horse based on exhibitor's age).

The showmanship class shall be designed to evaluate the exhibitor's ability to execute, in concert with a well-groomed and conditioned horse, a set of maneuvers prescribed by the judge with precision and smoothness while exhibiting poise and confidence, and maintaining a balanced, functional and fundamentally correct body position.

Method of Showing (Showmanship)

1. Walk, trot (or favorite gait for Saddle Horses only), turn, stop, back, and pose your horse as directed by the judge or ring steward.
2. Lead from the left side of your horse with your right hand on the lead strap. When showing your horse at a walk, walk by its side—never directly in front of it. Its head should be about even with your shoulder. When moving, keep your horse's neck, head, and body in a straight line, and maintain precise control. Move the horse directly toward or away from the judge, unless the judge indicates he wishes to see it from the side.
3. Show the horse with a shank short enough to assure maximum control and responsiveness from the horse. The basic position of

the exhibitor should allow constant observation of the horse's feet and also permit observation of the judge and ring officials.

4. Never obstruct the view of the judge, and do not stand directly in front of the horse.
5. Run by the left side of your horse when you are showing it at the trot (or favorite gait*). The horse should move willingly toward or away from the judge with its head, neck, and body in a straight line. It should trot freely and quickly and be alert with head up but not too high.
6. When a particular show ring procedure being used by a judge requires a horse to be reversed, it should be turned to the right. Turn in as small a space as possible and attempt to keep the horse's hind feet planted in one place while turning. All turns should be made natural. Any turn requiring more than 90 degrees should be made to the right.
7. Keep your horse posed at all times and know where the judge is and what he wants. A good showman always gives the judge the best view of the horse. You cannot change your horse's type and conformation, but you can improve its style and appearance. Make it easy for the judge to see your horse to its best advantage.
8. Keep your proper position in line and allow reasonable space (at least 6 feet) between your horse and the other horses. Never let your horse interfere with another horse.
9. Be alert when leading in a circle. Observe the horse in front of you; bumping this horse from the rear is a serious fault in showmanship and very unsafe.
10. If asked to change position in line, back your horse out of line and approach the new position from behind. Do not get too close.
11. Move easily, quietly, and with confidence when showing your horse. Be courteous, respond promptly to directions, and show good horsemanship at all times.
12. Do your showing with the lead shank.

Class Rules

1. It is mandatory that the judge post any pattern(s) to be worked at least 1 hour prior to the commencement of the class; however, if the judge requires additional work of exhibitors for consideration of final placing, the finals pattern may be posted. Pattern(s) should be designed to test the showman's ability to effectively present a horse to the judge. All ties will be broken at the judges' discretion.
2. CLASS PROCEDURES: All exhibitors may enter the ring and then work individually, or each exhibitor may be worked from the gate individually. When exhibitors are worked individually from the gate, a working order is required. The following maneuvers are considered acceptable: lead the horse at a walk, jog, trot, or extended trot (or favorite gait for Saddle Horses only), or back in a straight or curved line, or a combination of straight and curved lines; stop; and turn 90 (¼), 180 (½), 270 (¾), 360 (full turn) degrees or any combination or multiple of these turns. The judge must have exhibitors set the horse up squarely for inspection sometime during the class.
3. Showmanship whips (dressage whips, etc.) will not be allowed for showmanship purposes. War bridles or like devices, or any type of wire or rope over a horse's head, will not be allowed. A minimum gauge link of 4.0 mm is required.

4. **SCORING:** Exhibitors are to be scored from 0 to infinity, with 70 denoting an average performance. Patterns will be divided into 6 to 10 maneuvers, as specified by the judge, and each maneuver will be scored from +3 to -3 with ½-point increments acceptable that will be added or subtracted from 70. Maneuver scores should be determined independent of penalties and should reflect equal consideration of both performance of the exhibitor's pattern and the form and effectiveness of the exhibitor and presentation of horse to result in the following scores:

+3 Excellent, +2 Very Good, +1 Good, 0 Average or Correct, -1 Poor, -2 Very Poor, -3 Extremely Poor. Exhibitor's overall form and effectiveness should also be scored from 0 to 5 with 0 to 2 Average, 3 Good, 4 Very Good, 5 Excellent.

A. Overall Presentation of Exhibitor and Horse

The exhibitor's overall poise, confidence, appearance, and position throughout the class, and the physical appearance of the horse will be evaluated.

Presentation and Position of Exhibitor

- Appropriate attire must be worn. Clothes and person are to be neat and clean. The use of any type of artificial aid including but not limited to lighters, hay, dirt, sharp pins, etc. will be considered a disqualification.
- Exhibitors should be poised, confident, courteous, and genuinely sportsmanlike at all times, quickly recognizing and correcting faults in the positioning of the horse. The exhibitor should continue showing the horse until the class has been placed or he/she has been excused, unless otherwise instructed by the judge. The exhibitor should appear business-like, stand and move in a straight, natural, and upright manner, and avoid excessive, unnatural, or animated body positions.
- The exhibitor must lead on the horse's left side holding the lead shank in the right hand near the halter with the tail of the lead loosely coiled in the left hand unless requested by the judge to show the horse's teeth. It is preferable that the exhibitor's hand is not on the snap or chain portion of the lead continuously. The excess lead should never be tightly coiled, rolled, or folded. When leading, the exhibitor should be positioned between the eye and the mid-point of the horse's neck, referred to as the leading position.
- Both arms should be bent at the elbow with the elbows held close to the exhibitor's side and the forearms held in a natural position. Height of the arms may vary depending on the size of the horse and exhibitor, but the arms should never be held straight out with the elbows locked.
- The position of the exhibitor when executing a turn to the right is the same as the leading position except that the exhibitor should turn and face toward the horse's head and have the horse move away from him/her to the right.
- When executing a back, the exhibitor should turn from the leading position to face toward the rear of the horse with the right hand extended in front of the exhibitor's chest, still maintaining slight bend in the elbow, and walk forward. The ideal position is for the exhibitor's left shoulder to be in alignment with the horse's left front leg.
- When setting the horse up for inspection, the exhibitor should stand angled toward the horse in a position between the horse's eye and muzzle and should never leave the head of the horse. The exhibitor is required to use the Quarter Method when presenting the horse. The

exhibitor should maintain a position that is safe for himself/herself and the judge. The position of the exhibitor should not obstruct the judge's view of the horse and should allow the exhibitor to maintain awareness of the judge's position at all times. The exhibitor should not crowd other exhibitors when setting up side-by-side or head-to-tail. When moving around the horse, the exhibitor should change sides in front of the horse with minimal steps and should assume the same position on the right side of the horse that he/she had on the left side.

- Leading, backing, turning, and initiating the set-up should be performed from the left side of the horse. At no time should the exhibitor stand directly in front of the horse. The exhibitor should not touch the horse with his/her hands or feet, or visibly cue the horse by pointing his/her feet at the horse during the set-up.

Presentation of Horse

- The horse's body condition and overall fitness should be assessed. The hair coat should be clean, well-brushed, and in good condition. The mane, tail, forelock, and wither tuft may not contain ornaments (ribbons, bows, etc.), but may be braided or banded for English or Western. The length of mane and tail may vary, as long as they are neat, clean, and free of tangles. The mane should be even in length or may be roached, but the forelock and tuft over the withers must be left. The bridle path, eyebrows, and long hair on the head and legs may be clipped, except where government regulations prohibit.
- Hooves should be properly trimmed and if shod, the shoes should fit correctly and clinches should be neat. Hooves must be clean and may be painted black or with hoof dressings or shown naturally.
- Tack should fit properly and be neat, clean, and in good repair.

B. Performance

- The exhibitor should perform the work accurately, precisely, smoothly, and with a reasonable amount of speed. Increasing speed of the work increases the degree of difficulty; however, accuracy and precision should not be sacrificed for speed. The horse should lead, stop, back, turn, and set up willingly, briskly, and readily with minimal visible or audible cueing. A severe disobedience will not result in a disqualification but should be penalized severely, and the exhibitor should not place above an exhibitor who completes the pattern correctly. Excessive schooling or training, willful abuse, loss of control of the horse by the exhibitor, failure to follow prescribed pattern, knocking over or working on the wrong side of the cones shall be cause for disqualification.
- The horse should be led directly to and away from the judge in a straight or curved line and track briskly and freely at the prescribed gait as instructed. The horse's head and neck should be straight and in line with the body.
- The stop should be straight, prompt, smooth, and responsive, with the horse's body remaining straight.
- The horse should back up readily with the head, neck, and body aligned in a straight or curved line as instructed.
- On turns of greater than 90 degrees, the ideal turn consists of the horse pivoting on the right hind leg while stepping across and in front of the right front leg with the left front leg. An exhibitor should not be penalized if their horse performs a pivot on the left hind leg, but an exhibitor whose horse performs the pivot correctly should receive more credit.

- A pull turn to the left is an unacceptable maneuver.
- The horse should be set up quickly with the feet squarely underneath the body. The exhibitor does not have to reset a horse that stops square.

An exhibitor should be penalized in the pattern independent of maneuver scores and deducted from the final scores as follows:

Three points

- Break of gait at the walk or trot up to 2 strides
- Over or under turning up to 1/8 of a turn
- Ticking or hitting cone
- Sliding a pivot foot
- Lifting a pivot foot during a pivot or set-up and replacing it in the same place
- Lifting a foot in a set-up and replacing it in the same place after presentation

Five points

- Not performing the specific gait or not stopping within 10 feet (3 meters) of designated location
- Break of gait at walk or trot for more than 2 strides
- Splitting the cone (cone between the horse and exhibitor)
- Horse stepping out of or moving the hind end significantly during a pivot or turn
- Horse stepping out of set-up after presentation
- Horse resting a foot or hipshot in a set-up
- Over or under turning 1/8 to 1/4 turn

Ten points

- Exhibitor is not in the required position during inspection
- Exhibitor touching the horse or kicking or pointing his/her feet at the horse's feet during the set-up
- Standing directly in front of the horse
- Loss of lead shank, holding chain, or two hands on shank
- Blatant disobedience including biting, kicking, rearing, or pawing; horse continually circling exhibitor

Disqualifications (should not be placed)

- Loss of control of horse that endangers exhibitor, other horses, or judge
- Horse becomes separated from exhibitor
- Failure to display correct number
- Willful abuse
- Never performing specific gait
- Excessive schooling or training; use of artificial aids
- Knocking over the cone or going off pattern
- Illegal equipment
- Off pattern; including knocking over or wrong side of cone or marker; never performing designated gait; over or under turning more than 1/4 turn

Ranch Ground Handling Procedures and Scoring System (Classes 106-107)

****Rule:** A horse/exhibitor combination may participate in only one showmanship class (class 21-24 based on exhibitor's age, class 25-26 for saddle/gaited horses based on exhibitor's age, or class 106-107 for a ranch horse based on exhibitor's age).

1. This class tests the handler's ability to communicate with the horse from the ground by judging a series of maneuvers that require the horse to yield to pressure—forward, backward, and laterally. Maneuvers are selected to be realistic in their application to everyday training. Exhibitor movements should be workmanlike and efficient, and the horse should be obedient and cooperative. Evaluating safe and effective ground handling will take priority to the quality of attire or tack.
2. Each exhibitor will perform a pattern that will consist of no less than seven of the maneuvers listed below. Exhibitors may be asked to work from both the left and right side of the horse during any of the listed maneuvers (switching hands on the lead is permitted).
 - a. Square horse for inspection; judge will only walk in front of the horse. Exhibitor should use quarter-system in reference to the position of the judge at all times.
 - b. Lead the horse at a walk, jog/trot (or favorite gait for gaited horses only), or back in a straight or curved* line, or a combination of straight and curved* lines.
 - c. Extension of walk or trot.
 - d. Stop
 - e. Answer questions from the judge
 - f. Pivots, moving the forehand up to 270°
 - g. Move the hindquarters, up to 270° (turn on forehand)
 - h. Step away from the horse to the end of the lead while horse remains still
 - i. Lower the horse's head (pulling down on the lead or pressure on the poll)
 - j. Demonstrate a sidepass
 - k. Back the horse while handler remains stationary
1. Send horse in a circle (either direction), around a marker, or over a pole.

(*Curve = any non-straight line including, but not limited to: any change of direction from gradual turns to distinct turns, circles or portions of circles, or multiple curves to create a shape.)
3. Poles, barrels, and cones may be used as markers to define maneuver locations and/or parameters. However, the pattern should not take on the appearance of an "In-hand Trail" class. Hitting/touching/moving these objects will not be scored as penalties but will be taken into account when scoring the handler's abilities.
4. Exhibitors may be asked to work from both the left and right side of the horse during any of the listed maneuvers (switching hands on the lead is permitted). Exhibitors may touch the horse to initiate any lateral movement and when asked to lower the horse's head. The judge will recognize added degree of difficulty of not touching the horse, and this will be reflected in the maneuver score.

- Scoring will be on the basis of 0 to 100, with 70 denoting an average performance. Judges will assess each maneuver on a scale from -1½ to +1½ with ½-point increments in between. In addition to the maneuver score, exhibitors can incur penalty points as listed below.
- Penalties

One-half point

- Break of gait (walk or trot) up to one full stride

One point

- Touching horse other than when allowed. It is acceptable to touch the horse to sidepass, move the hindquarters, and lower the head.

Two points

- Freeze up: complete loss of forward, backward, or lateral movement within a maneuver
- Break of gait (walk or trot) for more than one full stride
- Use of hand on halter in any manner
- Touching horse with lead (first offense)
- Incorrect or incomplete answer to the judge's question
- Artificial or overdone showing

Five points

- Inappropriate body condition score: clearly below a 4 or clearly above a 7
- Balking, continued spooking, kicking, biting, rearing, striking
- Failure to complete a maneuver
- Touching horse with end of lead (second offense)

Disqualification (should not be placed)

- Consistent lameness
- Illegal attire
- Illegal tack
- Abuse
- Off pattern—performing obstacles incorrectly or omitting a maneuver

Saddle and Gaited Horse Division

Appointments

Western, English, or flat saddle. No martingales or tie-downs are allowed. Chain curbs are permissible but must meet the approval of the judge and must be at least ½ inch in width, flat against the jaw of the horse. For entire Saddle and Gaited Division, curb bit with shanks no more than 10 inches is acceptable. Bits, appointments, and attire should match the riding style. Wonder bits are acceptable as long as it adheres to the rules for that division. Western spurs are not allowed with English attire. English spurs are allowed. Set tails and artificial appliances are prohibited. Whips of 4 feet or less are allowed in any class where English attire and equipment are used. The whip must not be longer than 4 feet, including the snapper. Disqualified tack is what is inhumane or causes harm to the horse(s). Rider must wear appropriate attire (according to your type of tack—Western or English).

The following definitions were moved from the General Show Rules and Regulations section:

- Flat shod is defined as being shod with a shoe that is attached directly to the horse's hoof without the use of pads. No weights or pads will be attached to the shoe or to the horse's hoof.
- A padded shoe is defined as a shoe that uses one or more pads between the shoe and the horse's hoof.
- It is the exhibitor's responsibility to conform and adhere to the Horse Protection Act as passed by the U.S. Congress.

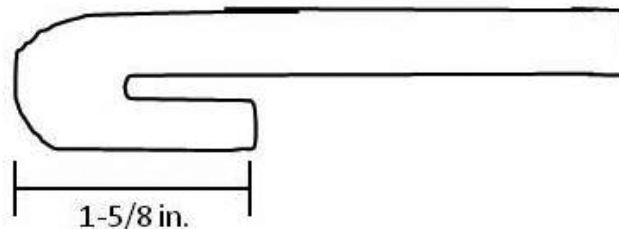

In all saddle and gaited classes, quarter boots may be used, but no chains, ropes, wire, rollers, or similar items will be used on the horse under or above the boots, or alone.

- Shoe must not exceed ½ inch in thickness and 1½ inch in width with no bare plates or other weight inside the shoe. Borium is allowed on caulks of the shoe, but the thickness of the shoe, caulk, and borium must not exceed 1⅛ inch with a maximum 1⅛ inches turn back (measures from back to front of caulk). The shoe must not exceed more than ¼ inch beyond the hoof at the toe.
- Shoeing bands, such as those used to anchor or strengthen pads and shoes, are permitted, so long as they are placed at least ½ inch below the coronet band. Shoeing bands are allowed in flat shod classes including Pleasure classes.
- The use of welded clips is prohibited in all flat shod classes. However, clips that are drawn from the shoe itself are allowed.
- No additional weights will be allowed in or on the hoof other than shoe and nails.

Performance and Manner of Horse

Prime consideration will be given to the horse that 1) performs with smooth, easy gait and manner; 2) shows responsiveness to the rider; and 3) exhibits a good disposition. Soundness and conformation are to be considered. Speed is a consideration in the rack (single foot) or running walk. A broken gait is not a disqualification.

Conformation

Suitable to the rider, serviceable, and sound.

Saddle and Gaited Horse Pleasure

27 Padded Saddle and Gaited Horse Pleasure, exhibitors 8–18 (show walk/favorite gait)

28 Saddle Horse Pleasure (flat shod), Jr. exhibitors 8–13 (show walk/favorite gait)

29 Saddle Horse Pleasure (flat shod), Sr. exhibitors 14–18 (show walk/favorite gait)

Gaits (two gaits required)

Show walk and favorite gait (foxtrot, running walk, stepping pace, rack, or single foot) both ways of the ring.

Country Pleasure

30 Country Pleasure (flat shod), exhibitors 8–18

Regular keg shoes consisting of $\frac{3}{8}$ " x $\frac{3}{4}$ " maximum shoe size with no bands allowed. No plantation shoes, and no pads. Walk and trail gait both directions of the arena. A back up is required. To be shown in western attire.

Racking Horse

31 Racking Horse (flat shod), Jr. exhibitors 8–13

32 Racking Horse (flat shod), Sr. exhibitors 14–18

33 Racking Horse (padded), exhibitors 8–18

Racking Horses

1. Horses may not be exhibited with artificial appliances. No boots or set tails.
2. Shoeing: refer to Appointments under the Saddle and Gaited Horse Division section for shoe guidelines.

Gaits

The racking horse is shown in each of the three natural gaits: the show walk, the slow rack, and the fast rack. In a workout, the judge may call for any or all of the required gaits, and horses must be worked both ways of the ring in the gaits requested by the judge. There will be no changing of tack after the exhibitor has entered the ring. Minor adjustments that may be made by the exhibitor momentarily while the horses are being reversed in the ring are allowed. This class is to be judged on performance and conformation of the horse at the discretion of the judge.

Saddle and Gaited Equitation

34 Saddle and Gaited Equitation, Jr. exhibitors 8–13

35 Saddle and Gaited Equitation, Sr. exhibitors 14–18

1. The Saddle and Gaited Equitation class is open to current 4-H members 8–13 and 14–18 years of age. Contestants and horses must be eligible according to the 2024 Mississippi 4-H Horse Show Classes, Rules, and Regulations.
2. This class will be held at the state show only with no district eliminations. Entries must be sent to Animal and Dairy Sciences, Attention: Dean Jousan, Box 9815, Mississippi State, MS 39762, by May 1 of the current year.
3. Judges should note that the required equitation seat should in no way be exaggerated but be thoroughly efficient and most comfortable for riding the type of horse called for at any gait and for any length of time. Rider should convey the impression of effective and easy control. To show a horse well, rider should show himself/herself to the best advantage. Ring generalship will be taken into consideration by the judge. A complete picture of the whole is of major importance. Riders will be judged on basic position in the saddle; position and use of hands, legs, and seat; ability to control and show the horse; and suitability of horse to rider. Results, as shown by the performance of the horse, are not to be considered more important than the methods used by the rider to obtain those results.

Seat: Position of hands, legs, and feet.

Basic Position: To obtain proper position, rider should place himself/herself comfortably in the saddle and find the center of gravity by sitting with a slight bend at the knees but without use

of irons. While in this position, adjust leathers to fit. Irons should be placed under balls of feet, with even pressure on entire width of soles. Lower legs and feet should be kept reasonably close but not in contact with horse, except when applying aids.

Hands: Hands should be held in an easy position, neither perpendicular nor horizontal to the saddle, and should show sympathy, adaptability, and control. The height at which the hands are held above the horse's withers is a matter of how and where the horse carries his head. The method of holding the reins is optional, except that both hands must be used and reins must be picked up at one time. Rider may ride one handed or two handed but must not switch from one to the other during the class.

Class Routine: Each rider will individually perform a given pattern within a set time period. The pattern may be composed of any combination of maneuvers listed in the optional list of tests. Failure to execute or complete the pattern will not cause disqualification but will be scored accordingly. It is recommended that the pattern be posted 1 hour in advance. The judge will use these work scores to determine the top riders who may be requested to perform additional individual work or rail work. Those selected riders (or all riders if the class is small) will be required to work on the rail to determine final placing. Riders selected for rail work will enter the ring in a counterclockwise direction. Riders will proceed at least once around the ring at each of the two gaits and on command, reverse and repeat. Any or all riders may be requested to perform additional work or tests. Horses will be asked to perform a walk and favorite gait.

Optional Tests for Saddle and Gaited Equitation Riders

Test may include but is not limited to the following:

1. Address the reins
2. Back for not more than eight steps
3. Figure eight at the walk or favorite gait
4. Execute a serpentine at the walk or favorite gait
5. Ride without stirrups for a brief period

Saddle and Gaited Trail

36 Saddle and Gaited Trail, exhibitors 8–18

Individual horse and exhibitor will negotiate an obstacle course consisting of six obstacles, three of which are mandatory, listed below. Final consideration of the judge will include quality and smoothness of performance of the horse and neatness and ability of exhibitor. The ideal trail horse will negotiate the course with surefootedness; look at the obstacles but not hesitate, yet not rush along the course; move willingly without excessive urging of exhibitor. Horse should show willingness to stand quietly on the bridge and not rush off. At the gate, the obstacle is not complete unless the gate is closed and should be judged accordingly. Horse should position himself at all times to enable the exhibitor to keep a hand on the gate until the gate is closed. Entry may be either English or Western, but not a combination of both. The method of holding the reins is optional, except that both hands must be used and reins must be picked up at one time. Rider may ride one-handed or two-handed but must not switch from one to the other during the class.

1. Mandatory Obstacles (may choose any three):
 - a. Opening, passing through, and closing gate (one that does not endanger horse or rider).

- b. Cavaletti (ride over at least four logs spaced on the ground).
- c. Ride over wooden bridge (may be plywood set to simulate sound and appearance of bridge).
- d. Back horse through L-shaped course (poles are suitable and must be a minimum of 30 inches in width).

2. Some Suggested Optional Obstacles:

- a. Mailbox.
- b. 360-degree hindquarter or forehand turn performed inside four poles placed 6-8 feet in width.
- c. Side pass in either direction over a pole on the ground.
- d. Back through three cones spaced 30-36 inches apart.
- e. Serpentine of six cones spaced close together for a walk through or back through.

3. Trail Obstacle Scoring and Penalties

- a. Scoring will be on the basis of 0-100, with 70 denoting an average performance. Each obstacle will receive an obstacle score that should be added or subtracted from 70 and is subject to a penalty that should be subtracted. Each obstacle will be scored on the following basis, ranging from plus 1½ to minus 1½: -1½ extremely poor, -1 very poor, -½ poor, 0 correct, +½ good, +1 very good, +1½ excellent. Obstacle scores are to be determined and assessed independently of penalty points. Penalties should be assessed per occurrence as follows:

- b. The following deductions will result:

One-half point

- Each tick of log, pole, cone, plant, or any component of the obstacle

One point

- Each bite of or hit of or stepping on a log, cone, plant, or any component of the obstacle
- Incorrect or break of gait at flat walk or running walk for two strides or less
- Both front or hind feet in a single-strided slot or space at a flat walk or running walk
- Skipping over or failing to step into required space
- Split pole in lope-over
- Incorrect number of strides, if specified

Three points

- Incorrect or break of gait at flat walk or running walk for more than two strides
- Out of lead or break of gait at lope (except when correcting an incorrect lead)
- Knocking down an elevated pole, cone, barrel, plant, obstacle, or severely disturbing an obstacle
- Stepping outside of the confines of, falling, or jumping off or out of obstacle with designated boundaries with one foot once the foot has entered obstacle; including missing one element of an obstacle on a line of travel with one foot

Five points

- Dropping slicker or object required to be carried on course

- First or second cumulative refusal, balk, or evading an obstacle by shying or backing
- Letting go of gate or dropping rope gate
- Use of either hand to instill fear or praise
- Stepping outside the confines of, falling, or jumping off or out of an obstacle with designated boundaries with more than one foot once the foot has entered obstacle; including missing one element of an obstacle on a line of travel with more than one foot
- Blatant disobedience (including kicking out, bucking, rearing, striking)

Faults that occur on the line of travel between obstacles, scored according to severity:

- head carried too high
- head carried too low (tip of ear below the withers)
- over-flexing or straining neck in head carriage so the nose is carried behind the vertical
- excessive nosing out
- opening mouth excessively
- Holding saddle with either hand

Disqualified (should not be placed)

- Performing the obstacle incorrectly or other than in specified order
- No attempt to perform an obstacle
- Equipment failure that delays completion of pattern
- Entering or exiting an obstacle from the incorrect side or direction
- Working obstacle the incorrect direction; including overturns of more than ¼ turn
- Riding outside designated boundary marker of the arena or course area
- Third cumulative refusal, balk, or evading an obstacle by shying or backing
- Failure to ever demonstrate correct gait between obstacle as designated
- Failure to follow the correct line of travel between obstacles
- Excessive schooling, pulling, turning, stepping, or backing anywhere on course
- Failure to open and shut gate or failure to complete gate

Faults scored according to severity that occur on the line of travel between obstacles include:

- Head carried too high
- Head carried too low (tip of ear below the withers)
- Over-flexing or straining neck in head carriage so the nose is carried behind the vertical
- Excessive nosing out
- Opening mouth excessively

Western Division

The following classes will follow the Personal Appointments, Tack, and Equipment sections in the Western Division: Halter, Western Pleasure, Horsemanship, Showmanship, Cow Horse Boxing, Reining, Western Riding, Trail, Ranch Ground Handling, Ranch Pleasure, Ranch Riding, Ranch Roping, and Ranch Trail.

Personal Appointments

Clothing must be clean and neat. Riders must wear Western hats or safety helmets and boots. Shirts with collars and long sleeves rolled down and buttoned are required. Spurs, chaps, and similar equipment are optional. Ball caps are not acceptable.

Tack

Horse must be shown with a stock saddle, but silver tack equipment will not count over a good working outfit. A snaffle, curb, half-breed, or spade bit is permissible; but a martingale, tie-down, or nose band is prohibited. No wire curbs, regardless of how taped, nor chin straps narrower than 1/2 an inch will be permitted. Chain curbs are permissible but must be of the standard flat variety with no twist and must meet approval of the judge. A hackamore or snaffle may be used only on horses or ponies 5 years of age or younger in Western events. "Hackamore" means that horse will be

ridden ONLY with a rawhide braided, leather braided, or rope bosal, the core of which may be either rawhide or flexible cable. A hackamore must use a complete mecate rein, which must include a tie-rein. Absolutely no iron will be permitted under the jaws, regardless of how padded or taped. Mechanical hackamores are prohibited. A judge has the authority to require the removal or alteration of any piece of equipment that in his/her opinion would give a horse an unfair advantage. Protective boots, leg wraps, and bandages are allowed in Western Horsemanship, Western Riding, Ranch Riding, Boxing, and Reining.

Bits: Snaffle bits used in Western Performance classes must be conventional egg-butt, O-ring, or D-ring type with a ring diameter no larger than 4 inches. The mouthpiece must be round and smooth and constructed of unwrapped metal. If the mouthpiece is inlaid, it must be smooth or latex-wrapped. The bars of the bit must measure at least 5/16 inch when measured 1 inch from the cheek. A gradual decrease toward the center of the bit is permissible. The mouthpiece may be of two or three pieces with either a connecting ring or a flat bar being the center. If the ring structure is used, it must be no larger than 1 1/4 inches in diameter; if the connecting piece is a flat bar, it can be no longer than 2 inches and must measure 3/8 to 3/4 inch top to bottom. Both the connecting ring and flat bar must lie in the horse's mouth. Curb bits are those bits that

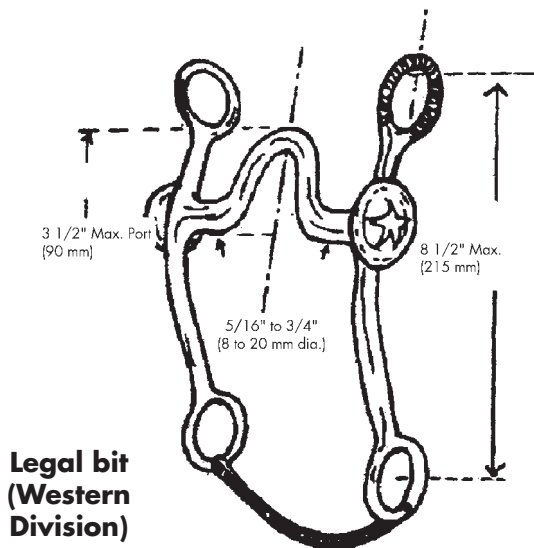

TYPICAL EXAMPLES OF ACCEPTABLE BITS OR BOSAL



Egg-Butt Snaffle Bit



O-Ring Snaffle Bit



D-Ring Snaffle Bit

Rawhide Bosal



A Bosal may also be used

(Western Division)

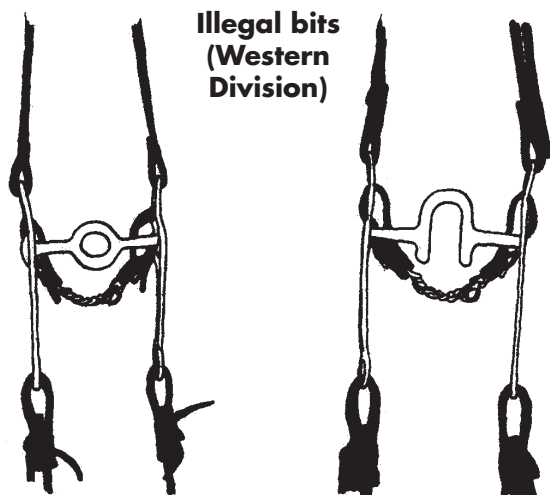

Illegal bits (Western Division)

Donut Bit

Prong Bit

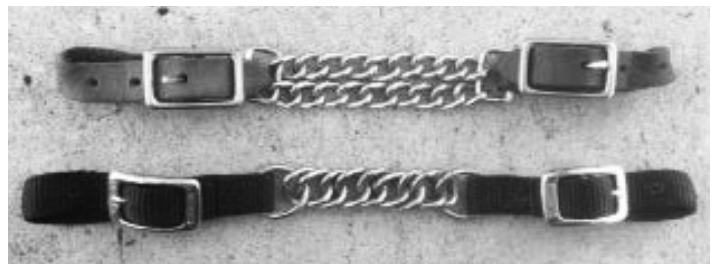

Acceptable curb chain straps



Unacceptable curb chain strap

have shanks used for leverage. The mouthpiece may be either smooth or broken. The bit must be free of mechanical devices. The length of the shank must not exceed 8½ inches measured from the upper inside of the top ring (where the headstall attaches) to the center of the bottom ring (where the reins attach). The bars of the curb bit must be round, smooth, unwrapped metal at least ¼ inch and no larger than ¾ inch in diameter when measured 1 inch from the cheek. If the mouthpiece is solid, nothing may protrude below the bar. If the mouthpiece is made of two or three pieces, a connecting ring 1¼ inches or smaller in diameter, or a connecting flat bar of ¾ to ¾ inch (measured top to bottom with a maximum length of 2 inches) that lies flat in the horse's mouth is acceptable. The maximum height of the port on a curb bit is 3½ inches measured from the bottom of the bar to the top of the port (this includes any extensions that might be added to the port). Slip and gag bits, and donut and flat polo mouthpieces are not acceptable. Horses or ponies 5 years of age or younger may be shown with both hands on reins in all Western division classes in accordance with the following rules:

1. Horses to be shown in standard, plain, or silver headstalls (browband, shaped ear, or split ear). Smooth snaffle bit with broken mouthpiece (conventional O-ring, egg-butt, or D-ring).
2. Reins are to be attached above the curb strap. (Curb chains are not legal to use on a snaffle bit.)
3. Standard, leather, or woven split reins are mandatory. Hair reins are not permitted with snaffle bits.
4. A rawhide braided, leather braided, or rope bosal may be used in lieu of a snaffle bit, with no metal under the jaw or on the noseband in connection with the bosal. The bosal should be properly fitted relative to the horse's size and conformation.
5. All entries with a hackamore/snaffle bit must be shown with both hands on reins, maintaining light contact with horse's mouth.
6. Reins must be held in one hand and cannot be changed during the performance, unless a horse or pony 5 years of age or younger is being shown in either a snaffle bit or bosal. If showing with one hand on the reins, the free hand must not be used to support the rider by being placed on any part of the saddle.
7. Contestants must use split reins or romal. Roping reins are not permitted. Only one finger between reins is permissible. When using a romal, no fingers between the reins are allowed. The free hand may not be used to adjust the rider's length of rein in any reining class. During reining, the use of the free hand while holding the romal to alter the tension or length of the reins from the bridle to the reining hand is considered to be the use of two hands, and a score of 0 will be applied, with the exception of any place a horse is allowed to be completely stopped during a pattern.
8. In all western classes, excess rein(s) may be straightened or disentangled anytime during the class, provided the rider's free hand used to straighten or disentangle remains behind the rein hand. Any attempt to alter tension or length of the reins from the bridle to rein hand is to be considered use of two hands and a penalty score of 0 or disqualification will be applied.

Western Pleasure

37 Pony Pleasure (all ponies; 52 inches and under), Jr. exhibitors 8–13 (lope required).

Rules of Western Pleasure class will apply.

40 Western Pleasure, Jr. exhibitors 8–11

41 Western Pleasure, Jr. exhibitors 12–13

42 Western Pleasure, Sr. exhibitors 14–15

43 Western Pleasure, Sr. exhibitors 16–18

****Rule:** A horse/rider combination may participate in either Pony Pleasure/Western Pleasure or Ranch Riding/Ranch Pleasure.

The Western Pleasure class will be judged on the performance, condition, and conformation of the horse. Horses are shown at a walk, jog, and lope on a reasonably loose rein or light contact without undue restraint. Horses must work both ways of the ring at all three gaits to demonstrate an ability with different leads. At the option of the judge, horses may be asked to lengthen their stride at the walk or lope, one or both ways of the ring. Never more than the top 12 horses may be asked to extend the lope. Judge may ask that horses be backed; however, only the finalists will be asked to back.

Horses may be required to reverse at walk or jog at the discretion of the judge, but horses will not be asked to reverse at the lope. Horses should pass on the inside, reverse toward center, be backed two lengths, and stand quietly. Reins will be held in one hand (except when showing horses 5 years old or younger with bosal or snaffle bit) and cannot be changed during the performance, and the hand will be around the reins. One finger between reins is permitted. Spurs or romal will not be used forward of the cinch. The free hand will not be used to support the rider by being placed on any part of the saddle. A good pleasure horse has a stride of reasonable length in keeping with his conformation. He has enough cushion to his pastern to give the rider a pleasant, smooth ride. He carries his head and neck in a natural position, not too high or too low, not overflexed at the poll, or excessively nosed out. Credit should be given to a horse that is relaxed but has its ears alert, looks balanced in its way of going, and is bright as well as responsive to the reins.

Other faults to be scored according to severity:

- Excessive speed or slowness (any gait)
- Being on the wrong lead
- Breaking gate (including not walking when called for)
- Excessive slowness in any gait, loss of forward momentum (resulting in an animated and/or artificial gait at the lope)
- Failure to take appropriate gait when called for (during transitions, excessive delay will be penalized)
- Touching horse or saddle with free hand
- Head carried too high
- Head carried too low (tip of ear below the withers)
- Overflexing or straining neck in head carriage so the nose is carried behind the vertical
- Excessive nosing out
- Excessive movement of the topline at the lope
- Opening mouth excessively
- Stumbling

- Use of spurs forward of the cinch
- If a horse appears sullen, dull, lethargic, emaciated, drawn, or overly tired
- Quick, choppy, or pony-strided
- If reins are draped to the point that light contact is not maintained
- Overly canted at the lope (when the outside hind foot is further to the inside of the arena than the inside foot)
- Changing hands on reins
- Two hands on reins, except when showing horses 5 years old or younger with bosal or snaffle bit
- Four-beat lope
- Broken diagonal jog

Western Walk/Jog

38 Western Pony Walk/Jog (ponies only), Jr. exhibitors 8–13

39 Western Walk/Jog (horses only), Jr. exhibitors 8–18

An exhibitor in classes 38 and 39 may also enter classes 45, 48-50, 53, 55, 61, 64-65, 70, and 97, as well as Halter and Showmanship, provided the exhibitor and horse/pony meet the entry qualifications for each class. Entry in other classes is prohibited. The Western Pony Walk/Jog and Western Walk/Jog classes do not count toward high point awards. One sibling may ride a horse in Western Walk/Jog and another sibling may ride the same horse in Western Pleasure.

The Western Pony Walk/Jog and Western Walk/Jog classes will be held at the state show with no district elimination (optional at district shows). Entries must be sent to Animal and Dairy Science Department, Attn: Dean Jousan, Box 9815, Mississippi State, MS 39762, by May 1 of the current year.

The Western Walk/Jog class will be judged on the performance, condition, and conformation of the horse at the discretion of the judge. Horses are shown at a walk and jog on a reasonably loose rein or light contact without undue restraint. Horses must work both ways of the ring at both gaits to demonstrate their ability. Judge might ask that horses be backed; however, only the finalists will be asked to back. Reference: See Western Pleasure.

Special Needs Walk/Jog Horsemanship

97 Special Needs Walk/Jog Horsemanship, exhibitors 8–18

An exhibitor in class 97 may also enter classes 38-39, 45, 50, 53, 55, 61, and 70, as well as Halter and Showmanship, provided the exhibitor and horse/pony meet the entry qualifications for each class. Entry in other classes is prohibited. The Special Needs Walk/Jog Horsemanship class does not count toward high point awards. One sibling may ride a horse in Special Needs Walk/Jog Horsemanship and another sibling may ride the same horse in Western Horsemanship.

1. Class 97 is open to special needs riders who are 4-H members 8–18 years of age. Participant is responsible for securing a horse but does not have to own his or her horse. If the special needs 4-H'er owns his or her own horse, he or she may enter and show only in English/Western Walk/Trot-Walk/Jog, Halter, and Showmanship classes.

2. This class will be held at district shows and the state show; however, participants do not have to qualify for the state show through the district show. Participants must make individual entries to the district shows or state show, or both. Entries for the district show must be sent to the district show secretary, and entries for the state show must be sent to Animal and Dairy Science Department, Attn: Dean Jousan, Box 9815, Mississippi State, MS 39762, by May 1 of the current year.
3. Horses may be ridden with English or Western bridles and saddles. Appropriate attire must be worn. Tack and attire must be clean, neat, and well-fitted. Elaborate equipment and fancy outfits will not be judged over good working clothes and tack.
4. Rider must wear a properly fitted equestrian helmet with a fastened chin harness. ASTM/SEI-approved helmets must be worn correctly (may be covered with a Western hat). It is the responsibility of the exhibitor or the parent, guardian, or trainer of exhibitor to ensure compliance.
5. Rider must wear appropriate boots or ride a saddle with safety stirrups. Effort must be made to use the stirrups. Peacock or covered irons for English and hooded safety stirrups for Western riders must be used if the rider cannot wear proper boots.
6. Rider must not be fastened to the saddle by any means. No seat belts, Velcro, rubber bands, or any other means may be used to fasten a rider to the saddle. A disabled rider could have a back rider if needed.
7. The rider MAY have a horse handler that has a lead line affixed to a halter over or under the horse's bridle. No lead lines may be fastened to the bridle or bit. The horse will be kept on the lead the entire time the class is in the ring or arena. The handler will allow the rider to control the horse as much as possible but will be alert for safety. In addition, a rider may have side walkers and a back rider (as many as four assistants are allowed). All assistants must be old enough to have a driver's license. Riders must have the horse handler in case an unsafe situation arises. The horse must be under control or the rider will be dismissed from the ring. Safety is of the utmost importance to all contestants. The judges will disregard all helpers and judge the class solely on the rider's abilities.
8. Horses to walk and jog both ways of the ring. Line up and back readily. Keeping safety in mind, the judge may ask riders to ride from the front to the back of the line, individually, at a walk or jog with their helpers.
9. This class judges the rider's abilities, seat, and appearance. The special needs rider desires to ride as the able rider, by the rules. They should try to the best of their abilities to sit and control and handle their mounts in accordance to the rules of horsemanship as stated in the American Quarter Horse Association Official Handbook. This class is not a stunt or a game but a test of the special needs rider's ability to correctly ride a horse.
10. The Special Needs Walk/Jog Horsemanship pattern to be used for this class will come from the AQHA Official Handbook.

Special Needs Walk/Jog Horsemanship Pattern

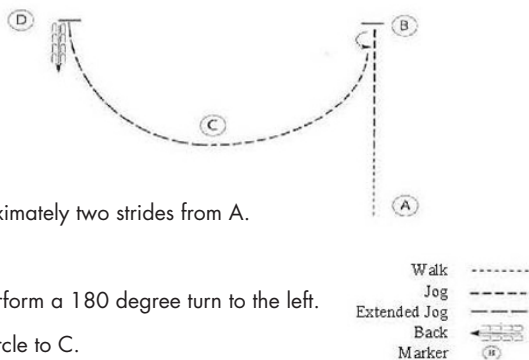

Be ready at A.

1. Walk approximately two strides from A.
2. Jog to B.
3. Stop and perform a 180 degree turn to the left.
4. Jog a half circle to C.
5. Extend the jog to D.
6. Stop at D and back approximately one horse length. Follow the instructions of your ring steward.

Western Riding

44 Western Riding, exhibitors 8–18

Exhibitors may be asked to run pattern 1, 2, or 4 at the judge's discretion.

1. Western Riding is an event where the horse is judged on quality of gaits, lead changes at the lope, response to the rider, manners, and disposition. The horse should perform with reasonable speed and be sensible, well-mannered, free, and easy moving.
 - a. Only one hand may be used on the reins (except when showing horses 5 years old or younger with bosal or snaffle bit), and the hands must not be changed.
 - b. The hand is to be around the reins. One finger between the reins is permitted.
 - c. While the horse is in motion, rider's hands must be clear of the horse and the saddle.
 - d. Spurs or romal will not be used forward of the cinch.
2. Credit will be given for and emphasis placed on smoothness, even cadence of gaits (starting and finishing pattern with the same cadence), and the horse's ability to change leads precisely, easily, and simultaneously both hind and front at the center point between markers. In order to have balance, with quality lead changes, the horse's head and neck should be in a relaxed, natural position, with its poll level with or slightly above the level of the withers. It should not carry its head behind the vertical, giving the appearance of intimidation, or be excessively nosed out, giving a resistant appearance. The horse should have a relaxed head carriage showing response to the rider's hands, with a moderate flexion at the poll. Horses may be ridden with light contact or on a reasonably loose rein. The horse should cross the log both at the jog and the lope without breaking gait or radically changing stride.
3. The judge will select one of the three patterns to be performed. The judge is responsible for the pattern being correctly set.
4. On the pattern:
 - a. The 8 or 10 small Xs represent pylon makers that are recommended. These should be separated by a uniform measured distance of not less than 30 feet nor more than 50 feet

on the sides with five markers (see diagram). In pattern 1, the three markers on the opposite side should be set adjacent to the appropriate markers. It is recommended that markers be set a minimum of 15 feet from the fence and with 50 to 80 feet width in the pattern, as the arena permits.

- b. A solid log or pole should be used and be a minimum of 8 feet in length.
 - c. The long serpentine line indicates the direction of travel and gaits at which the horse is to move. The recommended lead changing point is equal to half a stride length before or after the center point between the markers. The dotted line (.....) indicates walk, the dashed line (- - -) indicates jog, and the solid line (___) indicates lope.
 - d. A cone will be placed along the wall or rail of the arena to designate where the exhibitor should initiate the walk. On pattern 1, the cone should be placed a minimum of 15 feet before the first pylon. On patterns 2 and 3, the cone should be placed even with the first pylon. The on-deck exhibitor should not go to the start cone until the contestant on pattern has cleared the working area by the start cone for the final time.
5. Scoring will be on a basis of 0–100, with 70 denoting an average performance. Points will be added or subtracted from the maneuvers on the following basis, ranging from +1½ to -1½:

-1½ extremely poor

-1 very poor

-½ poor

0 average

+½ good

+1 very good

+1½ excellent

Maneuver scores are to be determined independently of penalty points.

6. A contestant will be penalized each time the following occurs:

One-half point

- Tick or light touch of log

One point

- Hitting or rolling log
- Out of lead more than one stride either side of the center point and between the markers
- Splitting the log (log between the two front or two hind feet) at the lope
- Hind legs skipping or coming together during lead change
- Break of gait at the walk or jog up to two strides
- Non-simultaneous lead change (front to hind or hind to front)

Three points

- Not performing the specific gait (jog or lope) or not stopping when called for in the pattern, within 10 feet of the designated area
- Simple change of leads

Western Riding Pattern Number 1

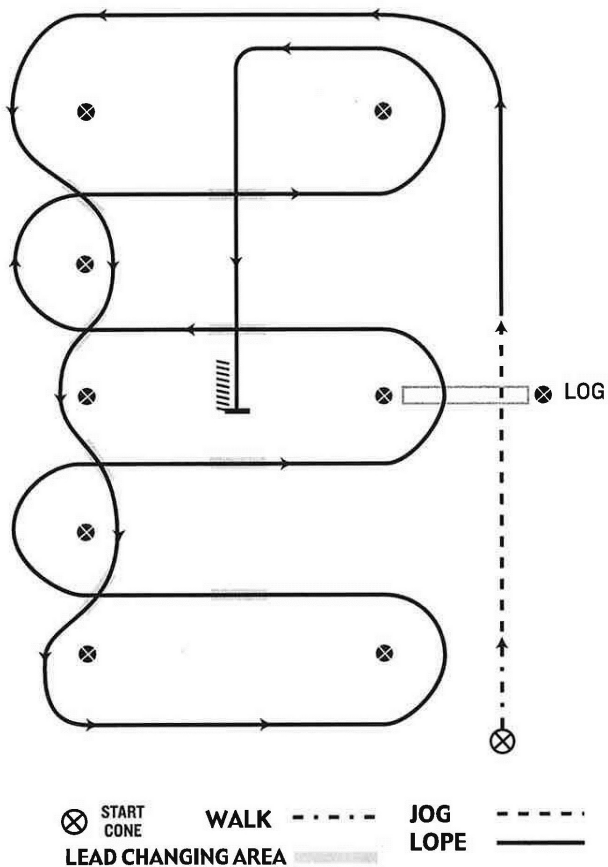

1. Walk at least 15 feet from start cone to the first marker over log. Start jogging at first marker and jog over log.
2. Transition to left lead and lope around end.
3. First line change.
4. Second line change.
5. Third line change.
6. Fourth line change; lope around the end of arena.
7. First crossing change.
8. Second crossing change.
9. Lope over log.
10. Third crossing change.
11. Fourth crossing change.
12. Lope up the center, stop, and back.

- Out of lead at or before the marker prior to the designated change area or out of lead at or after the marker after the designated change area
- Additional lead changes anywhere in the pattern (except when correcting an extra change or incorrect lead)
- In patterns 1 and 3, failure to start the lope within 30 feet after crossing the log at the jog
- Break of gait at walk or jog for more than two strides
- Break of gait at the lope

Western Riding Pattern Number 2

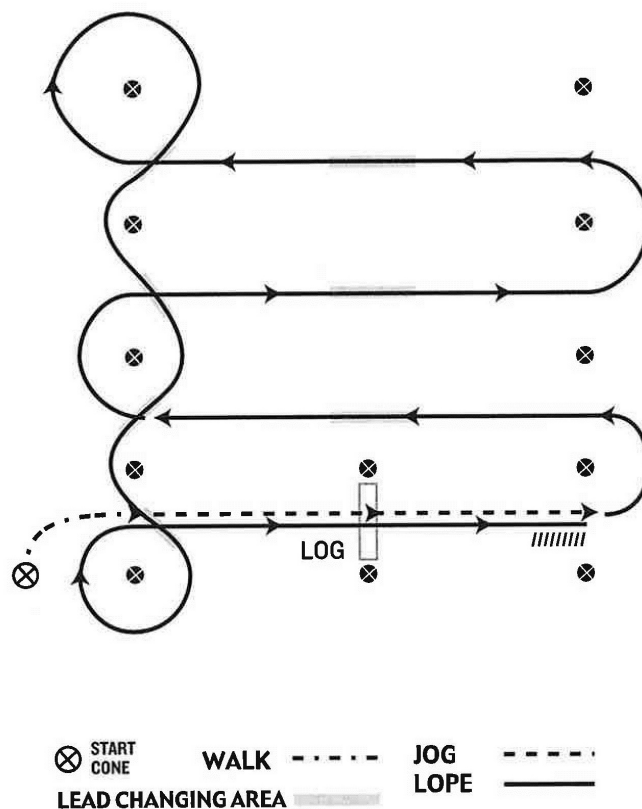

1. Walk, transition to jog, jog over log
2. Transition to the lope, on the left lead
3. First crossing change
4. Second crossing change
5. Third crossing change
6. Circle and first line change
7. Second line change
8. Third line change
9. Fourth line change and circle
10. Lope over log
11. Lope, stop, and back

Five points

- Out of lead beyond the next designated change area. (Note: failures to change, including cross-cantering; two consecutive failures to change would result in two five-point penalties.)
- Blatant disobedience including kicking out, biting, bucking, and rearing.
- Holding saddle with either hand
- Use of either hand to instill fear or praise

Disqualified (should not be placed)

- Illegal equipment
- Willful abuse
- Off course

- Knocking over markers
- Completely missing log
- Major refusal (stop and back more than two strides or four steps with front legs)
- Major disobedience or schooling
- Failure to start lope prior to end cone in pattern 1
- Four or more simple lead changes and/or failures to change leads
- Failure to start lope beyond 30 feet of designated area in patterns 2 and 3
- Overturn of more than ¼ of a turn
- Faults, which will be cause for disqualification except in novice amateur or novice youth classes, will be scored according to severity:
 - › Head carried too low (tip of ear below withers consistently)
 - › Overflexing or straining neck in head carriage so the nose is carried behind the vertical consistently

Credits

- Changes of leads, hind and front simultaneously
- Change of lead near the center point of the lead change area
- Accurate and smooth pattern
- Even pace throughout
- Easy to guide and control with rein and leg
- Manners and disposition
- Conformation and fitness

Faults

The following characteristics are considered faults and should be judged accordingly in maneuver scores:

- Opening mouth excessively
- Anticipating signals
- Stumbling
- Head carried too high
- Head carried too low (tip of ear below the withers)
- Overflexing or straining neck in head carriage so the nose is carried behind the vertical
- Excessive nosing out

Western Horsemanship

45 Western Horsemanship Walk/Jog, exhibitors 8–18

An exhibitor in class 45 may also enter classes 38-39, 48-50, 53, 55, 61, 64-65, 70, and 97, as well as Halter and Showmanship, provided the exhibitor and horse/pony meet the entry qualifications for each class. Entry in other classes is prohibited. The Western Horsemanship Walk/Jog class does not count toward high point awards. One sibling may ride a horse in Western Walk/Jog and another sibling may ride the same horse in Western Horsemanship.

The Western Horsemanship Walk/Jog class will be held at the state show with no district elimination (optional at district shows). Entries must be sent to Animal and Dairy Science Department, Attn: Dean Jousan, Box 9815, Mississippi State, MS 39762, by May 1 of the current year.

Western Riding Pattern Number 4

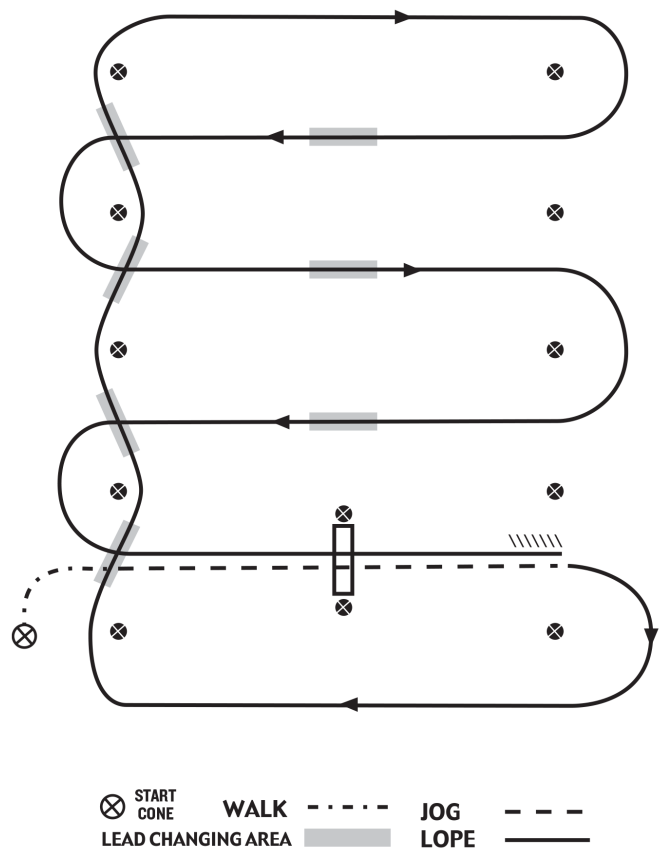

1. Walk, transition to jog, jog over log.
2. Transition to the lope, on the right lead.
3. First line change.
4. Second line change.
5. Third line change.
6. Fourth line change.
7. First crossing change.
8. Second crossing change.
9. Third crossing change.
10. Lope over log.
11. Lope, stop, and back.

All rules for classes 46-47 apply for class 45 Western Horsemanship Walk/Jog (exhibitor 8-18) except that the course must be designed to require each horse to show the two gaits (walk and jog) as part of its work.

46 Western Horsemanship, Jr. exhibitors 8–13

47 Western Horsemanship, Sr. exhibitors 14–18

1. General
 - a. The western horsemanship class is designed to evaluate the rider's ability to execute, in concert with his/her horse, a set of maneuvers prescribed by the judge with precision and smoothness while exhibiting poise and confidence, and maintaining a balanced, functional, and fundamentally correct body position. The ideal horsemanship pattern is extremely precise with the rider and horse working in complete unison,

executing each maneuver with subtle aids and cues. The horse's head and neck should be carried in a relaxed, natural position, with the poll level with or slightly above the withers. The head should not be carried behind the vertical, giving the appearance of intimidation, or be excessively nosed out, giving a resistant appearance.

- b. It is mandatory that the judge post any pattern(s) to be worked at least 1 hour prior to the commencement of the class; however, if the judge requires additional work of exhibitors for consideration of final placing, the pattern may be posted. Pattern(s) should be designed to test the horseman's ability. All ties will be broken at the judge's discretion.
- c. CLASS PROCEDURES: All exhibitors must enter the ring and then work individually, or each exhibitor may be worked from the gate individually. When exhibitors are worked individually from the gate, a working order is required. Exhibitors should be instructed to either leave the arena, fall into line, or fall into place on the rail after their work. The whole class, or only the finalists, must work at all three gaits at least one direction of the arena. The following maneuvers are acceptable in a pattern: walk, jog, trot, extended trot, lope or extended lope in a straight line, curved line, serpentine, circle or figure 8, or combination of these gaits and maneuvers; stop; back in a straight or curved line; turn or pivot, including spins and rollbacks on the haunches and/or on the forehand; sidepass, two-track or leg-yield; flying or simple change of lead; counter-canter; or any other maneuver; or ride without stirrups. A back should be asked for at some time during the class. Judges should not ask exhibitors to mount or dismount.
- d. SCORING: Exhibitors are to be scored from 0 to infinity, with 70 denoting an average performance. Patterns will be divided into 6 to 10 maneuvers, as specified by the judge, and each maneuver will be scored from +3 to -3 with ½-point increments acceptable that will be added or subtracted from 70. Maneuver scores should be determined independent of penalties and should reflect equal consideration of both performance of the exhibitor's pattern and the form and effectiveness of the exhibitor and presentation of horse to result in the following scores:
+3 Excellent, +2 Very Good, +1 Good, 0 Average or Correct, -1 Poor, -2 Very Poor, -3 Extremely Poor. Exhibitor's overall form and effectiveness should also be scored from 0 to 5 with 0 to 2 Average, 3 Good, 4 Very Good, 5 Excellent.

A. Overall Presentation of Exhibitor and Horse

The exhibitor's overall poise, confidence, appearance and position throughout the class as well as the physical appearance of the horse will be evaluated.

Presentation and Position of Exhibitor

- Appropriate western attire must be worn. Clothes and person are to be neat and clean. The use of any artificial aid or magnetic device will result in disqualification.
- The exhibitor should appear natural in the seat and ride with a balanced, functional, and correct position regardless of the maneuver or gait being performed. During the rail work and pattern, the exhibitor should have strong, secure, and proper position. Exhibitors should sit and maintain an upright position with the upper body at all gaits.
- The rider should sit in the center of the saddle and the horse's back with the legs hanging to form a straight line from the ear, through

the center of the shoulder and hip, touching the back of the heel or through the ankle. The heels should be lower than the toes, with a slight bend in the knee, and the lower leg should be directly under the knee. The rider's back should be flat, relaxed, and supple. An overly stiff and/or overly arched lower back will be penalized. The shoulders should be back, level, and square. The rider's base of support should maintain secure contact with the saddle from the seat to the inner thigh. Light contact should be maintained with the saddle and horse from the knee to mid-calf. The knee should point forward and remain closed with no space between the exhibitor's knee and the saddle. The exhibitor will be penalized for positioning the legs excessively behind or forward of the vertical position. Regardless of the type of stirrup, the feet may be placed home in the stirrup, with the boot heel touching the stirrup, or may be placed with the ball of the foot in the center of the stirrup. The rider's toes should be pointing straight ahead or slightly turned out with the ankles straight or slightly broken in. Riding with toes only in the stirrup and riding without contact of bottom of boot securely on pad of stirrup will be penalized. Those exhibitors who can maintain the proper position throughout all maneuvers should receive more credit. When riding without stirrups, the exhibitor should maintain the same position as previously described. Both hands and arms should be held in a relaxed, easy manner, with the upper arm in a straight line with the body. The arm holding the reins should be bent at the elbow, forming a line from the elbow to the horse's mouth. The free hand and arm may be carried bent at the elbow in a similar position as the hand holding the reins or straight down at the rider's side. Excessive pumping of the free arm as well as excessive stiffness will be penalized. The rider's wrist is to be kept straight and relaxed, with the hand held at about 30 to 45 degrees inside the vertical. The rein hand should be carried immediately above or slightly in front of the saddle horn. The reins should be adjusted so that the rider has light contact with the horse's mouth, and at no time shall reins require more than a slight hand movement to control the horse. Excessively tight or loose reins will be penalized.

- The rider's head should be held with the chin level and the eyes forward, and may be directed slightly toward the direction of travel. Excessive turning of the head to the inside of the circle, or down at the horse's head or shoulder will be penalized.
- The exhibitor should not crowd the exhibitor next to or in front of him/her when working on the rail and should pass to the inside of the arena. When reversing on the rail, the exhibitor should always reverse to the inside of the arena.

Presentation of Horse

- The horse's body condition and overall health and fitness should be assessed. The horse should appear fit and carry weight appropriate for the body size. A horse that appears sullen, dull, lethargic, emaciated, drawn, or overly tired should be penalized according to severity.
 - Tack should fit the horse properly and be neat, clean, and in good repair.
- #### 2. Performance
- The exhibitor should perform the work accurately, precisely, smoothly, and with a reasonable amount of promptness. Increasing speed of the maneuvers performed increases the degree of difficulty; however, accuracy and precision should not be sacrificed for speed. Exhibitors who perform the pattern sluggishly and allow their horse to move without adequate impulsion, collection, or cadence will be penalized.

- The horse should perform all maneuvers in the pattern willingly, briskly, and readily with minimal visible or audible cueing. Severe disobedience will not result in a disqualification, but should be severely penalized, and the exhibitor should not place above an exhibitor that completes the pattern correctly. Failure to follow the prescribed pattern, knocking over or working on the wrong side of the cones, excessive schooling or training, or willful abuse by the exhibitor is cause for disqualification.
- The horse should track straight, freely, and at the proper cadence for the prescribed gait. Transitions should be smooth and prompt in the pattern and on the rail, and should be performed when called for on the rail. The horse's head and neck should be straight and in line with its body while performing straight lines and slightly arched to the inside on curved lines or circles. Circles should be round and performed at the appropriate speed, size, and location as requested in the pattern. The counter-canter should be performed smoothly with no change in cadence or stride unless specified in the pattern.
- The stop should be straight, square, prompt, smooth, and responsive with the horse maintaining a straight body position throughout the maneuver. The back should be smooth and responsive.
- Turns should be smooth and continuous. When performing a turn on the haunches, the horse should pivot on the inside hind leg and step across with the front legs. A rollback is a stop and 180 degree turn over the hocks with no hesitation. Backing during turns will be penalized severely.
- The horse should step across with the front and hind legs when performing the sidepass, leg-yield, and two-track. The sidepass should be performed with the horse keeping the body straight while moving directly lateral in the specified direction. When performing a leg-yield, the horse should move forward and lateral in a diagonal direction with the horse's body arced opposite to the direction that the horse is moving. In the two-track, the horse should move forward and lateral in a diagonal direction with the horse's body held straight or bent in the direction the horse is moving.
- A simple or flying change of lead should be executed precisely in the specified number of strides and/or at the designated location. A simple change of lead is performed by breaking to a walk or trot for one to three strides. Flying changes should be simultaneous front and rear. All changes should be smooth and timely.
- Position of the exhibitor and performance of the horse and rider on the rail must be considered in the final placing.

PENALTIES. An exhibitor should be penalized in the pattern independent of maneuver scores and deducted from the final score as follows:

Three points

- Break of gait at the walk or jog up to 2 strides
- Over or under turn from $\frac{1}{8}$ to $\frac{1}{4}$ turn
- Tick or hit of cone

Five points

- Not performing the specific gait or not stopping within 10 feet (3 meters) of designated location
- Incorrect lead or break of gait at the lope (except when correcting an incorrect lead)
- Break of gait at walk or jog for more than 2 strides

- Loss of stirrup
- Bottom of boot not touching pad of stirrup at all gaits including backup
- Head carried too low and/or clearly behind the vertical while the horse is in motion, showing the appearance of intimidation
- Obviously looking down to check leads

Ten points

- Loss of rein
- Use of either hand to instill fear or praise while on pattern or during rail work
- Holding saddle with either hand
- Cueing with the end of the romal
- Blatant disobedience including kicking, pawing, bucking, and rearing
- Spurring in front of the cinch

Disqualifications (should not be placed) include:

- Failure to display correct number
- Abuse of horse or schooling
- Knocking over the cone, going off pattern, or working on wrong side of cone
- Fall by horse or rider
- Illegal equipment or illegal use of hands on reins
- Use of prohibited equipment
- Off pattern, including: knocking over cone or wrong side of cone or marker; never performing designated gait or lead; over or under turning more than $\frac{1}{4}$ turn

Faults scored according to severity, which will be cause for disqualification include:

- Head carried too low and/or clearly behind the vertical excessively and consistently while the horse is in motion, or otherwise showing the appearance of intimidation.

Western Trail

50 Walk/Jog Trail, exhibitors 8–18

An exhibitor in class 50 may also enter classes 38-39, 45, 48-49, 53, 55, 61, 64-65, 70, and 97, as well as Halter and Showmanship, provided the exhibitor and horse/pony meet the entry qualifications for each class. Entry in other classes is prohibited. The Walk/Jog Trail classes (Jr. and Sr.) do not count toward high point awards. One sibling may ride a horse in Walk/Jog Trail and another sibling may ride the same horse in Trail.

1. The Western Walk/Jog Trail class will be held at the state show with no district elimination (optional at district shows). Entries must be sent to Animal and Dairy Science Department, Attn: Dean Jousan, Box 9815, Mississippi State, MS 39762, by May 1 of the current year.
2. All rules for classes 50–51 apply for Western Walk/Jog Trail class 49 except that the course must be designed to require each horse to show the two gaits (walk and jog) as part of its work.

51 Trail Class, Jr. exhibitors 8–13

52 Trail Class, Sr. exhibitors 14–18

****Rule:** A horse/rider combination may participate in only one trail class (either Western Trail or Ranch Trail).

1. This class is open to all horses and ponies. Riders must have Western attire and Western tack.
2. This class will be judged on the performance of the horse over obstacles with emphasis on manners, response to the rider, and quality of movements. Credit will be given to horses negotiating the obstacles with style and some degree of speed, providing correctness is not sacrificed. Horses will receive credit for showing attentiveness to obstacles, for capably picking their own way through the course when obstacles warrant it, and for willingly responding to the rider's cues on more difficult obstacles.
3. Horses will be penalized for any unnecessary delay while approaching or negotiating the obstacles. Horses with artificial appearance over obstacles will be penalized.
4. Horses are not required to work on the rail. However, the course must be designed to require each horse to show the three gaits (walk, jog, lope) somewhere between obstacles as a part of its work. Quality of movement and cadence will be considered as part of the maneuver score. Gait between obstacles will be at the discretion of the judge.
5. Scoring will be on the basis of zero to infinity, with 70 denoting an average performance. Each obstacle will receive an obstacle score to be added or subtracted from 70 and is subject to a penalty that will be subtracted. Each obstacle will be scored on the following basis, ranging from +1½ to -1½:

-1½ extremely poor

-1 very poor

-½ poor

0 correct

+½ good

+1 very good

+1½ excellent

Obstacle scores will be determined independently of penalty points. Penalties will be assessed per occurrence as follows.

6. A contestant will be penalized each time the following occurs:

One-half point

- Each tick of log, pole, cone, plant, or any component of the obstacle

One point

- Each bite or hit of or stepping on a log, cone, plant, or any component of the obstacle
- Incorrect or break of gait at walk or jog for two strides or fewer
- Both front or hind feet in a single-strided slot or space at a walk or jog
- Skipping over or failing to step into required space
- Split pole in lope-over
- Incorrect number of strides, if specified

Three points

- Incorrect or break of gait at walk or jog for more than two strides

- Out of lead or break of gait at lope (except when correcting an incorrect lead)
- Knocking down an elevated pole, cone barrel, or plant obstacle, or severely disturbing an obstacle
- Falling or jumping off or out of a bridge with one foot once the horse has gotten onto or into that obstacle
- Stepping outside of the confines of an obstacle with designated boundaries (i.e., back through, 360 box, side pass) with one foot once the horse has entered the obstacle
- Missing or evading a pole that is a part of a series of an obstacle with one foot

Five points

- Dropping slicker or object required to be carried on course
- First or second cumulative refusal, balk, or evading an obstacle by shying or backing
- Letting go of gate or dropping rope gate
- Use of either hand to instill fear or praise
- Falling or jumping off or out of a bridge with more than one foot once the horse has gotten onto or into that obstacle
- Stepping outside of the confines of an obstacle with designated boundaries (i.e., back through, 360 box, side pass) with more than one foot once the horse has entered the obstacle
- Missing or evading a pole that is a part of a series of an obstacle with more than one foot
- Blatant disobedience (including kicking out, bucking, rearing, striking)
- Holding saddle with either hand
- Faults that occur on the line of travel between obstacles, scored according to severity:
 - › head carried too low (tip of ear below the withers)
 - › overflexing or straining neck in head carriage so the nose is carried behind the vertical
 - › excessive nosing out
 - › opening mouth excessively

Disqualified (should not be placed)

- Use of two hands or changing hands on reins, except for junior horses shown with hackamore or snaffle bit. Only one hand may be used on the reins, but it is permissible to change hands to work an obstacle as outlined in Western Division - Tack, or to straighten reins when stopped.
- Use of romal other than as outlined in Western Division - Tack
- Performing the obstacles incorrectly or other than in the specified order
- No attempt to perform an obstacle
- Equipment failure that delays completion of pattern
- Excessively or repeatedly touching the horse on the neck to lower the head
- Entering or exiting an obstacle from the incorrect side or direction

- Working obstacle the incorrect direction; including overturns of more than ¼ of a turn
- Riding outside designated boundary marker of the arena or course area
- Third cumulative refusal, balk, or evading an obstacle by shying or backing
- Failure to ever demonstrate correct gait between obstacles as designated
- Failure to follow the correct line of travel between obstacles
- Excessive schooling, pulling, turning, stepping, or backing anywhere on course
- Failure to open and shut gate or failure to complete gate

Faults scored according to severity that occur on the line of travel between obstacles include:

- head carried too high
- head carried too low (tip of ear below the withers)
- over-flexing or straining neck in head carriage so the nose is carried behind the vertical
- excessive nosing out
- opening mouth excessively

Mandatory Obstacles

- Open, pass through, and close rope gate
- Ride over at least four logs or poles
- Backing obstacles (May be spaced at a minimum of 28 inches; if elevated, 30-inch spacing is required. Entrants cannot be asked to back over a stationary object such as a wooden pole or metal bar.)
 - › Back through and around at least three markers.
 - › Back through L, V, U, straight, or similar course. May be elevated no more than 24 inches.

Optional Obstacles

- Side pass (may be elevated to 12-inch maximum)
- Ride over wooden bridge
- Serpentine obstacles at walk or jog, with spacing at a minimum of 6 feet for jog
- Carry object from one part of arena to another (Only objects that might be carried on a trail ride may be used.)
- Put on and remove slicker
- Remove and replace materials from mailbox
- An obstacle consisting of four logs or rails, laid in a square. Minimum width of the square should be 6 feet. Each contestant will enter the square by riding over a log or rail as designated. When all four feet are inside the square, rider will execute a turn, as indicated, and depart.

Special Needs Walk/Jog Trail

53 Special Needs Walk/Jog Trail, exhibitors 8–18

An exhibitor in class 53 may also enter classes 38-39, 45, 50, 55, 61, 70, and 97, as well as Halter and Showmanship, provided the exhibitor and horse/pony meet the entry qualifications for each class. Entry in other classes is prohibited. The Special Needs Walk/Jog Trail class does not

Special Needs Walk/Jog Trail Pattern 1

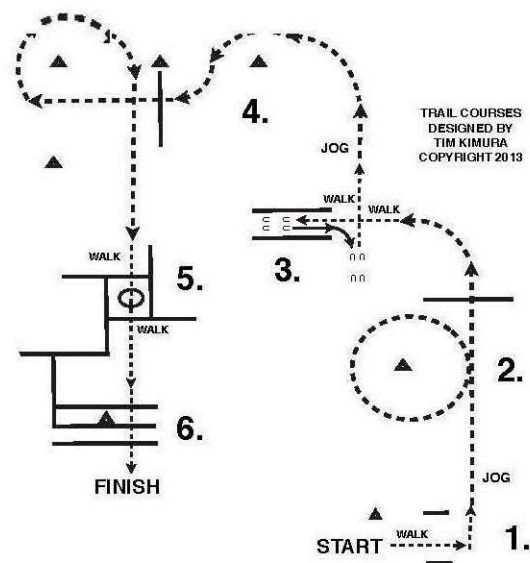

Be ready at start cone.

1. Gate walk through opened gate.
2. Jog circle around cone and jog over pole.
3. Stop or break to walk; walk into chute. Back through poles, turn, and walk forward.
4. Jog around cones and over pole.
5. Stop or break to walk, walk into box, execute a 360 turn to either direction, and walk out of box.
6. Walk over poles to finish. Follow the instructions of your ring steward.

count toward high point awards. One sibling may ride a horse in Special Needs Walk/Jog Trail and another sibling may ride the same horse in Trail.

1. All rules and regulations for class 97 Special Needs Walk/Jog Horsemanship apply for class 53 Special Needs Walk/Jog Trail.
2. This class will be judged on the performance of the horse and rider while maneuvering five obstacles.
3. Results as shown by the performance of the horse are not to be considered more important than the manner used in obtaining them when judging this class.

Reining

54 Reining, exhibitors 8–18

All horses are eligible for this division. Juniors and seniors may be required to run reining pattern 1, 2, 4, 9, or 11. The pattern to be run will be at the judge's discretion.

1. Each horse will be judged on the neatness, dispatch, ease, calmness, and speed with which it performs the pattern. The horse will rein and handle easily, fluently, effortlessly, and with reasonable speed throughout the pattern.
2. Any horse not following the exact pattern will be disqualified.
3. A judge will have the authority to require the removal or alteration of any piece of equipment or appointment that, in the

judge's opinion, would tend to give a horse an unfair advantage. Any inhumane equipment will be scored accordingly.

4. Only one hand may be used on reins (except when showing horses 5 years old or younger with bosal or snaffle bit), and hands must not be changed. The hand must be around the reins. One finger between the reins is permitted. Spurs or a romal will not be used forward of the cinch. While the horse is in motion, the rider's hand will be clear of the horse and saddle.
5. Horses 6 years and older must be shown in a bit (curb, snaffle, spade, or half-breed), ridden with one hand; horses 5 years old and younger may be shown with a bosal. Mechanical hackamores are prohibited.
6. Each contestant will perform the required pattern individually and separately. All horses will be judged immediately upon entering the arena, and judging will cease after the last maneuver. Any fault incurred before beginning a pattern will be scored accordingly.
7. To rein a horse is not only to guide him but also to control his every movement. The best-reined horse should be willfully guided or controlled with little or no apparent resistance and dictated to completely. Any movement on his own must be considered a lack of control. All deviations from the exact written pattern must be considered a lack of or temporary loss of control, and, therefore, faulted according to severity of deviation. Credit will be given for smoothness, finesse, attitude, quickness, and authority in performing the various maneuvers while using controlled speed.
8. Scoring will be a basis of zero to infinity, with 70 denoting an average performance. The individual maneuvers are scored in half-point increments from a low of $-1\frac{1}{2}$ to a high of $+1\frac{1}{2}$ with a score of zero denoting a maneuver that is correct with no degree of difficulty.
9. The following will result in no score (should not be placed):
 - a. Abuse of an animal in the show arena and/or evidence that an act of abuse has occurred before or during the exhibition of a horse in competition
 - b. Use of illegal equipment, including wire on bits, bosals, or curb chains
 - c. Use of illegal bits, bosals, or curb chains; when using a snaffle bit, optional curb strap is acceptable; however, curb chains are not acceptable
 - d. Use of tack collars, tie downs, or nose bands
 - e. Use of whips or bats
 - f. Use of any attachment that alters the movement of or circulation to the tail
 - g. Failure to provide horse and equipment to the appropriate judge for inspection
 - h. Disrespect or misconduct by the exhibitor
 - i. Closed reins are not allowed except as standard romal reins.
 - j. Excess rein may be straightened anytime during the pattern, provided the rider's free hand remains behind the rein hand. Any attempt to alter tension or length of the reins from bridle to the rein hand is to be considered use of two hands, and a penalty score of zero will be applied. In addition, should the judge determine

the free hand is being used to instill fear or praise, a penalty of five and a reduction in the maneuver score will be applied.

10. The following will result in a score of zero (should not be placed):
 - a. Use of more than index (first) finger between reins
 - b. Use of two hands (exception in Snaffle Bit or Hackamore classes designated for two hands) or changing hands
 - c. Inappropriate use of romal, which is the extension of braided material attached to closed reins. This extension may be carried in the free hand with a 16-inch spacing between the reining hand and the free hand holding the romal.

Reining Pattern Number 1

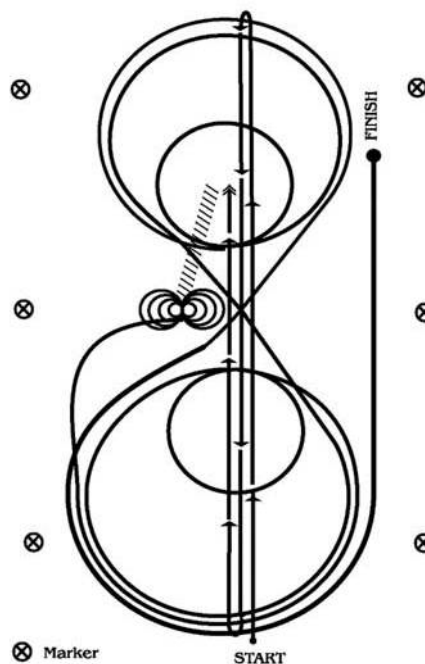

1. Run at speed to the far end of the arena past the end marker and do a left rollback with no hesitation.
2. Run to the opposite end of the arena past the end marker and do a right rollback with no hesitation.
3. Run past the center marker and do a sliding stop. Back up to center of the arena or at least 10 feet. Hesitate.
4. Complete four spins to the right.
5. Complete $4\frac{1}{4}$ spins to the left so the horse is facing left wall or fence. Hesitate.
6. Beginning on the left lead, complete three circles to the left: the first circle large and fast, the second circle small and slow, and the third circle large and fast. Change leads at the center of the arena.
7. Complete three circles to the right: the first circle large and fast, the second circle small and slow, and the third circle large and fast. Change leads at the center of the arena.
8. Begin a large, fast circle to the left but do not close this circle. Run straight up the right side of the arena past the center marker and do a sliding stop at least 20 feet from wall or fence. Hesitate to demonstrate the completion of the pattern. Rider may drop bridle to the designated judge.

- d. Failure to complete pattern as written
- e. Performing the maneuvers other than in specified order
- f. The inclusion of maneuvers not specified, including, but not limited to—
 - backing more than two strides
 - turning more than 90 degrees
- g. Equipment failure that delays completion of pattern, including dropping a rein that contacts the ground while horse is in motion
- h. Balking or refusal of command where performance is delayed
- i. Running away or failing to guide where it becomes impossible to discern whether the entry is on pattern

- j. Jogging in excess of half of a circle or half the length of the arena
- k. Overspins of more than ¼ of a turn
- l. Fall to the ground by horse or rider
- m. When going to and coming out of a rollback in a pattern requiring a run-around, a rollback that crosses the center line
- n. Exceeds greater than one quarter of the circle out of order

A no score or a zero is not eligible to place in a go-round or class.

11. The following will result in a reduction of five points:

Reining Pattern Number 2

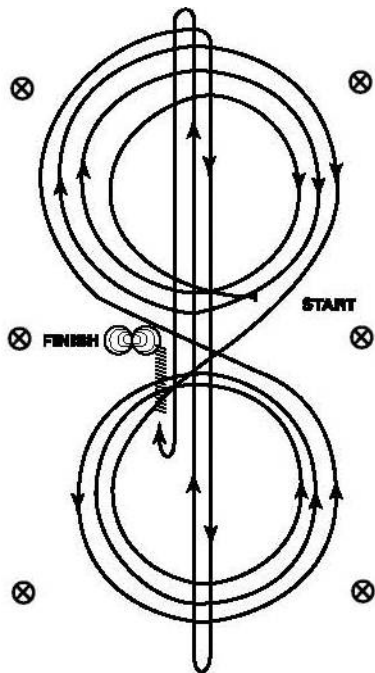

Horse must walk or stop prior to starting pattern. Begin at the center of the arena facing the left wall or fence.

1. Beginning on the right lead, complete three circles to the right: the first circle small and slow, the next two circles large and fast. Change leads at the center of the arena.
2. Complete three circles to the left: the first circle small and slow, the next two circles large and fast. Change leads at the center of the arena.
3. Continue around previous circle to the right. At the top of the circle, run down the middle to the far end of the arena past the end marker and do a right roll back with no hesitation.
4. Run up the middle to the opposite end of the arena past the end marker and do a left roll back with no hesitation.
5. Run past the center marker and do a sliding stop. Back up to center of the arena or at least 10 feet. Hesitate.
6. Complete four spins to the right.
7. Complete four spins to the left. Hesitate to demonstrate the completion of the pattern. Rider may drop bridle to designated judge.

Reining Pattern Number 4

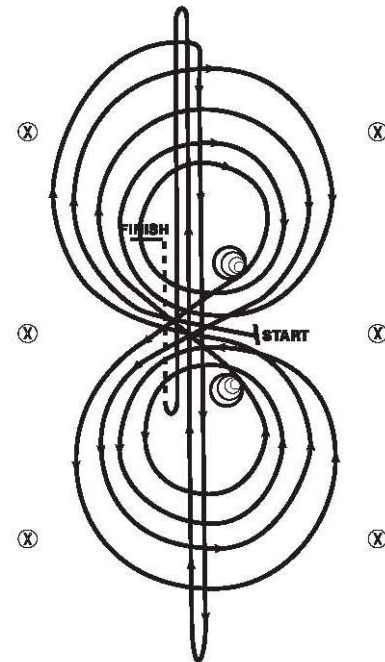

Horse must walk or stop prior to starting pattern. Begin at the center of the arena facing the left wall or fence.

1. Beginning on the right lead, complete three circles to the right: the first two circles large and fast, the third circle small and slow. Stop at the center of the arena.
2. Complete four spins to the right. Hesitate.
3. Beginning on the left lead, complete three circles to the left: the first two circles large and fast, the third circle small and slow. Stop at the center of the arena.
4. Complete four spins to the left. Hesitate.
5. Beginning on the right lead, run a large, fast circle to the right; change leads at the center of the arena; run a large fast circle to the left; change leads at the center of the arena.
6. Continue around previous circle to the right. At the top of the circle, run down the middle to the far end of the arena past the end marker and do a right roll back with no hesitation.
7. Run up the middle to the opposite end of the arena past the end marker and do a left rollback with no hesitation.
8. Run past the center marker and do a sliding stop. Back up to the center of the arena or at least 10 feet. Hesitate to demonstrate completion of the pattern. Rider may drop bridle to the designated judge.

- a. Spurring in front of cinch
 - b. Use of free hand to instill fear or praise
 - c. Holding saddle with either hand
 - d. Blatant disobedience including kicking, biting, bucking, rearing, and striking
12. The following will result in a reduction of two points:
- a. Failing to completely pass the specified marker before initiating a stop motion
 - b. Break of gait
 - c. Freeze up in spins or rollbacks

- d. On walk-in patterns, failure to stop or walk before executing a canter departure
- e. On run-in patterns, failure to be in a canter before the first marker

13. Starting or performing circles or figure eights out of lead will be judged as follows: Each time a horse is out of lead, a judge is required to deduct one point. The penalty for being out of lead is accumulative, and the judge will deduct one penalty point for each quarter of the circumference of a circle or any part thereof that a horse is out of lead. A judge is required to penalize a horse half a point for a delayed change of lead by one stride where the lead change is required by the pattern description.

Reining Pattern Number 9

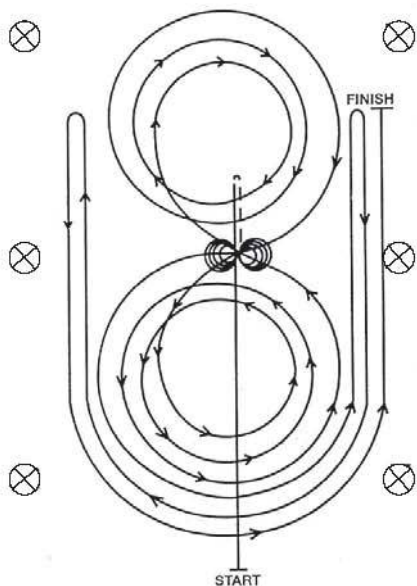

1. Run past the center marker and do a sliding stop. Back up to the center of the arena or at least 10 feet. Hesitate.
2. Complete four spins to the right.
3. Complete 4¼ spins to the left so your horse is facing the left wall or fence. Hesitate.
4. Beginning on the left lead, complete three circles to the left: the first circle small and slow, the next two circles large and fast. Change leads at the center of the arena.
5. Complete three circles to the right: the first circle small and slow, the next two circles large and fast. Change leads at the center of the arena.
6. Begin a large, fast circle to the left but do not close this circle. Run up the right side of the arena past the center marker and do a right rollback at least 20 feet from the wall or fence with no hesitation.
7. Continue back around the previous circle, but do not close this circle. Run up the left side of the arena past the center marker and do a left rollback at least 20 feet from the wall or fence with no hesitation.
8. Continue back around previous circle but do not close this circle. Run up right side of the arena past the center marker, and do a sliding stop at least 20 feet from the wall or fence. Hesitate to demonstrate completion of the pattern. Rider may drop bridle to the designated judge.

Reining Pattern Number 11

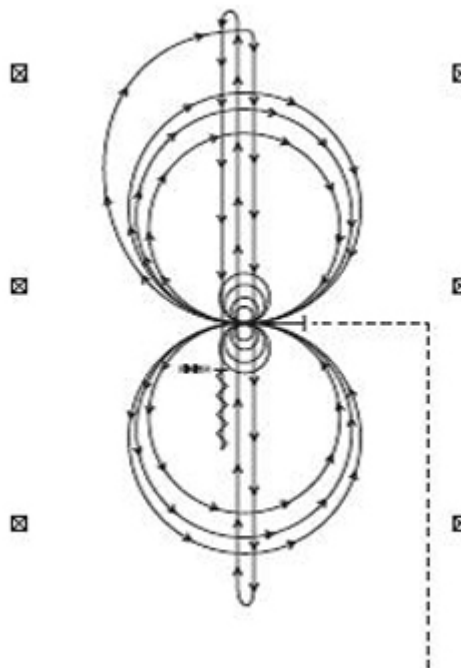

Horse must jog the majority of the way to the center. Failure to jog the majority of the way to the center will result in a 0 for failure to complete the pattern as written. Horses must walk or stop prior to starting pattern. Begin at the center of the arena facing the left wall or fence.

1. Complete four spins to the left. Hesitate.
2. Complete four spins to the right. Hesitate.
3. Beginning on the right lead, complete three circles to the right: the first circle small and slow; the next two circles large and fast. Change leads at the center of the arena.
4. Complete three circles to the left: the first circle small and slow; the next two circles large and fast. Change leads at the center of the arena.
5. Begin a large circle to the right, but do not close this circle. Run down the center of the arena past the end marker and do a right rollback – no hesitation.
6. Run up the middle to the opposite end of the arena past the end marker and do a left rollback – no hesitation.
7. Run past the center marker and do a sliding stop. Back up to the center of the arena or at least 10 feet. Hesitate to demonstrate completion of the pattern.

14. Deduct ½ point for starting circle at a jog or exiting rollbacks at a jog up to two strides. Jogging beyond two strides, but less than half of a circle or half the length of the arena, deduct two points.
15. Deduct ½ a point for over- or under-spinning up to ⅛ of a turn; deduct one point for over- or under-spinning from ⅛ to ¼ of a turn.
16. A half-point penalty deduction will be given for failure to remain a minimum of 20 feet from the wall or fence when approaching a stop and/or rollback.
17. In patterns requiring a run-around, failure to be on the correct lead when rounding the end of the arena will be penalized as follows: for half the turn or less, one point; for more than half the turn, two points.
18. In patterns requiring a run-around, there will be a ½ point penalty for failure to remain a minimum of 10 feet from either side of the center of the arena; for small arenas, it will be at the judge's discretion.
19. A judge may require any contestant to repeat performance of any or all of the various parts of the pattern.
20. Faults against the horse to be scored accordingly, but not to cause disqualification:
 - a. Opening mouth excessively when wearing bit
 - b. Excessive jawing, opening mouth, or head raising on stop
 - c. Lack of smooth, straight stop on haunches, bouncing, or sideways stop
 - d. Refusing to change leads
 - e. Anticipating signals
 - f. Stumbling
 - g. Backing sideways
 - h. Knocking over markers
21. Faults against the rider to be scored accordingly but not to cause disqualification:
 - a. Losing stirrup
 - b. Failure to run circles or figure eights within the markers is not considered a fault, depending on arena conditions and size; however, failure to go beyond markers on rollbacks and stops is considered a fault.

Working Cow Horse (Boxing Only)

95 Working Cow Horse (boxing only), Jr. 8–13

96 Working Cow Horse (boxing only), Sr. 14–18

1. This class consists only of the boxing portion (cow work).
2. Scoring will be on the basis of 0 to 100, with 70 denoting an average performance.
3. The show committee may provide two to four herd holders to facilitate returning the cow to the holding pen after each run.
4. Scoring emphasis on the cow work portion shall be based on the horse maintaining control of the cow at all times, exhibiting superior cow sense and natural cow working ability without excessive reining or spurring. Failure of an exhibitor to attempt to complete the cow work portion of the class will result in the exhibitor being disqualified and not eligible for placing. A

horse that attempts to complete the cow work and has not been disqualified will be scored accordingly by the judges. However, the fall of a horse and rider being judged shall be cause for disqualification and not eligible for placing.

5. Cow Work

- a. **Boxing the Cow** – The rider will face the cattle entry gate. The rider shall signal for his/her cow to be turned into the arena. Each contestant upon receiving a cow in the arena shall hold that cow on the prescribed end of the arena for 50 seconds, demonstrating the ability of the horse and rider to control the cow. Time shall begin when the gate closes behind the cow after being let into the arena. The announcer or judge will signal the completion of the 50 seconds with a whistle or horn. If the cow does not immediately challenge the horse, the rider shall aggressively move in on the cow to demonstrate his horse's ability to drive and block the cow on the entry fence. There shall be no schooling between the completion of the rein work and the cow work, or between cows if a new cow is awarded.
- b. The judge should take into consideration the size of the arena, condition of ground, and disposition and degree of difficulty exhibited by the cattle worked.
- c. The entry shall be penalized, per occurrence, in the boxing portion for:

Five-point penalties

- Spurring or hitting in front of cinch at any time, or excessively whipping or spurring the horse; blatant disobedience defined as kicking, biting, bucking, rearing, striking, or obviously insubordinate

Three-point penalties

- Loss of control and cow leaves end of arena

One-point penalties

- Loss of working advantage
- Working out of position

Zero score (disqualification; should not be placed)

- Turn tail
 - Fingers between the reins
 - Leaving the work area before the pattern or work is complete
 - Out of control
 - Any horse that runs over the cow, thus causing the fall of horse and/or rider, shall terminate the work at that time.
 - Use of two hands on the reins, except with junior horses ridden two-handed in a bosal or snaffle bit
 - Schooling between cows, if new cow is awarded
 - Fall of horse or rider
 - The judge may blow his/her whistle at any time to terminate the work; a score of zero will be charged if the work is not complete at that point.
6. If time and number of cattle permit, the judge may, at his discretion, award new cattle to enable the contestant to show his horse's ability on the cow, based on the following criteria:
 - The cow won't or can't run

- The cow runs blind or won't yield to the horse
- The cow leaves the arena

Miniature In Hand Classes

The Miniature In Hand Trail and Miniature In Hand Over Fences classes count toward a horse's and exhibitor's high point awards, but they do not count toward a division high point.

48 Miniature In Hand Trail, Jr. 8-13

49 Miniature In Hand Trail, Sr. 14-18

1. The Miniature In Hand Trail class will be held at the state show with no district elimination (optional at district shows). Entries must be sent to Animal and Dairy Science Department, Attn: Dean Jousan, Box 9815, Mississippi State, MS, 39762, by May 1 of the current year.
2. Class to be judged on performance and way of going with emphasis on manners throughout course. Entries will be evaluated on responsiveness and willingness, plus general attitude.
3. Maximum time 60 seconds per obstacle; judges are encouraged to advance on to the next obstacle any horse taking excessive time at an obstacle. Horse to be penalized for any unnecessary delay or excessive time at object. Refusals do not constitute class disqualifications.
4. Obstacle requirements:
 - a. Must be a minimum of five obstacles and a maximum of eight.
 - b. Care must be used to avoid setting any obstacle in a way so as to be hazardous to the horse or exhibitor.
 - c. Tires and stair steps are prohibited.
 - d. Jumps, if used, must be a maximum of 12 inches high and a minimum length of 5 feet. Jumps must include ground poles.
5. Baiting to encourage an animal to perform one of the obstacles is not allowed. Any baiting in such class is a disqualification.
6. Obstacle Guidelines:

The course designer should be readily available to answer questions regarding the course and be available for a walk through the course with exhibitors as well as the judge(s). Judge shall walk the In Hand course with designer and exhibitors. Ingenuity and originality in adapting and combining various obstacles both to demonstrate a horse's willingness and ability to please exhibitors and audience are encouraged. However, unnatural or "horror" obstacles should be avoided and all obstacles should be safe for exhibitors as well as horses. Judge has the right to alter the course for time and/or safety.
7. Suggested Obstacles:
 - a. Back through or out of obstacle.
 - b. Put on and remove equipment (raincoat, saddle, etc.) from person or horse.
 - c. Walk through narrow passage.
 - d. Pick up an object (letter, umbrella, bucket, flag, etc.) and place it at a designated location.
 - e. Walk across bridge or simulated bridge.
 - f. Walk pattern created with poles, pylons, (figure 8, serpentine, cloverleaf, etc.).

- g. Stand horse in circle, ground tie, walk around horse.
- h. Side-pass (either or both directions).

8. Off course is defined as:

- a. Taking an obstacle in the wrong direction
- b. Negotiating an obstacle from the wrong side
- c. Skipping an obstacle unless directed by judge
- d. Negotiating obstacles in the wrong sequence
- e. Side pass the wrong end of horse in the obstacle
- f. Off pattern

Off course will result in elimination. (No points, ribbons, or awards will be presented).

9. Scoring will be on the basis of 0 to infinity, with 70 denoting an average performance. Each obstacle will receive an obstacle score to be added or subtracted from 70 and is subject to a penalty that will be subtracted. Each obstacle will be scored on the following basis, ranging from +1½ to -1½:

-1½ extremely poor

-1 very poor

-½ poor

0 correct

+½ good

+1 very good

+1½ excellent

10. Obstacle scores will be determined independently of penalty points. Penalties will be assessed per occurrence as is done for Junior and Senior Trail.

11. Mandatory obstacle dimensions for Miniature In Hand Trail Class are as follows:

- a. Walk overs, minimum width: 18-20"

Multiple poles, minimum width: 20"

Single poles, maximum height: 8"

Multiple poles, maximum height: 6"

Rolling poles are prohibited.

- b. Jog overs, minimum: 30"

Raised maximum height: 6"

- c. Jog arounds or serpentine 6' min, 8' max

- d. Back thrus or arounds

On ground, minimum width: 24"

Elevated, minimum width: 28"

Barrels, minimum width: 30"

- e. Side pass, minimum width: 24"

Raised, minimum height: 24"

- f. Circle turn around, minimum: 22"

- g. Cavaletti

Jog overs 3' to 3'6" apart (space is measured between poles)

Lope overs 6' to 7' apart (7' is preferable for most horses)

Jog overs raised, maximum height: 10"

Lope overs raised, maximum height: 10"

h. Jumps

Lead over, maximum height: 18" horse only

Maximum height: 12" horse and handler

Lead over, minimum width between standards: 3'

Lead over, multiple jumps, maximum height: 12"

Box and L-jumps, poles must be at least 12' long

i. Serpentine jog arounds

Pylons 6' min - 8' max apart (base to base)

Guardrails 6' to 8' to either side of the pylons

j. Serpentine walk-around

Pylons 3' apart (base to base) minimum

Guardrails 3' to either side of pylons

If tall standards are used, dimensions may be looser.

k. Gate

Approximately 60" high with latch available at that height.

l. Any other maneuvers

Calculate the wheel base of a horse as 5' from front hooves to back hooves.

12. Obstacles

a. Measurements to be taken with accurate measuring device (i.e., measuring tape, ruler, or yard stick).

b. Measurements to be taken from the inside width of poles or obstacles.

64 Miniature In Hand Over Fences, Jr. 8-13

65 Miniature In Hand Over Fences, Sr. 14-18

1. The Miniature In Hand Over Fences class will be held at the state show with no district elimination (optional at district shows). Entries must be sent to Animal and Dairy Science Department, Attn: Dean Jousan, Box 9815, Mississippi State, MS, 39762, by May 1 of the current year.
2. The Miniature In Hand Over Fences class course must be posted at least 1 hour prior to the scheduled time of the class. Judge(s) shall walk the course with designer and exhibitors. Course diagrams must show with arrows the direction each obstacle must be taken. A start and finish line must be established at least 24 feet from the first and last obstacle if possible, indicated by two markers at least 4 feet apart. Horses (exhibitors optional) must cross the line in the proper direction to start and complete the course. Horses must stay within the course boundaries as outlined by the start and finish cone. The start and/or finish cones outline the portion of the course in the immediate areas of the starting (first) and finishing (last) obstacles only, not the entire course. Baiting of horses to encourage an animal to perform any of the jumps is not allowed. Baiting in such class is a disqualification.
3. Jumps should be made of 1- to 1½-inch schedule 40 PVC piping or other suitable lightweight material with jump cups, not to include pegs, nails, bolts, etc. All jumps must be a minimum of 5 feet wide, with a minimum of 18 feet between jumps, with the exception

of an in and out. In and outs should be set approximately 12 feet apart. Jumps 32 inches or more in height must have a second rail added. All post and rail jumps must have a ground pole. Uprights to be a maximum of 48 inches in height. No jumps, including jump-offs to exceed 44 inches. Any decorations or jump wings must not protrude more than 24 inches from the uprights.

4. Miniature In Hand Over Fences entries are to be judged on style, manners, and way of going with preference given to those horses who cover the course at an even pace, with free flowing strides, as in a brisk trot or canter, but must maintain same gait throughout course. Circling once upon entering the ring and once upon leaving the ring is permissible. Hunters must demonstrate at least one, but no more than four changes of direction. Sample courses to be provided to show management. Charging fences or not maintaining the same gait throughout the entire course shall be penalized. Upon completion of the entire class over jumps, finalists will be trotted past the judge(s) for soundness check. Horses shall not be required to rejump the course. Exhibitor's footwear is optional.
5. Jumps must be a minimum height of 18 inches and maximum of 24 inches. Ground poles are required. There will be a minimum of four obstacles, and horses are to make a minimum of six jumps and a maximum of eight jumps. Jumps must simulate those found in the hunting field, such as brush, stone wall, gate, white fence, chicken coop, over, and in and out. In and out is considered one obstacle and scored as such. Refusal of one element of an in and out requires the retaking of both elements. In and out must never be placed at the beginning of the course. Courses should be tried out so as not to make turns too sharp for an exhibitor or horse. Major faults to be considered are: knockdowns, touches, refusals, bucking or kicking, spooking or shying, showing obstacle to horse, or wringing tail.
6. The scoring system for Working Hunter will apply to this class in addition to the following causes for elimination.
 - a. Three refusals
 - b. Off course
 - c. Crossing your own path
 - d. Fall of horse or exhibitor
 - e. Jumping of obstacle by exhibitor
 - f. Carrying of whip
 - g. An unsound horse
 - h. Jumping of obstacle before being reset
 - i. Failure to pass through the start and/or finish cones and/or knocking such cones over

Hunter Division

The following classes will follow the Personal Appointments, Tack, and Equipment sections in the Hunter Division: Hunter Under Saddle, Hunt Seat Equitation, Working Hunter, Cross Rails, Equitation Over Fences, and Jumping.

Personal Appointments

Exhibitors should wear hunt coats of traditional colors such as navy, dark green, gray, black, or brown. Maroon and red are inappropriate. Shirts should be conservative in color with a choker/rat catcher, snap choker,

or tie. Breeches are to be of traditional shades of buff, khaki, canary, light gray, or rust with high English boots or paddock (Jodhpur) boots of black or brown. Riders are allowed to wear black or brown half chaps in English classes. A black, navy blue, or brown hard hat with fastened chinstrap is mandatory for all over-fence classes. ASTM/SEI helmets are required (see rule 34 on page 15). Gloves, spurs of the unrowelled type, and crops or bats are optional. Hair must be neat and contained (as in a net or braid). Judges must penalize contestants who do not conform; however, judges, at their discretion, may authorize adjustments to attire due to weather-related conditions.

Tack Appointments

1. An English snaffle (no shank), kimberwick, pellham, and/or full bridle (with two reins), all with cavesson nosebands and plain leather brow bands must be used.

Acceptable English Bits

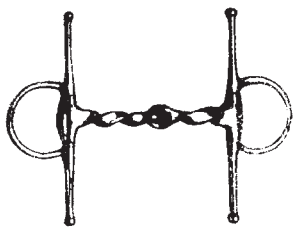

Slow twist

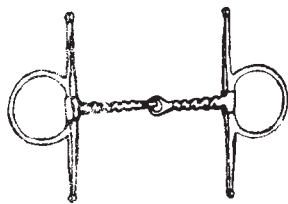

Corkscrew

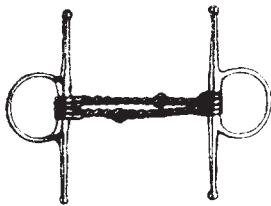

Double twisted wire

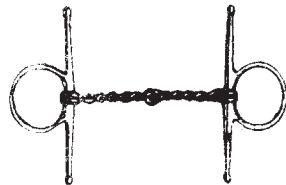

Single twisted wire

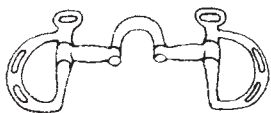

Correction bit



Snaffle bit with connecting flat bar

Unacceptable English Bits

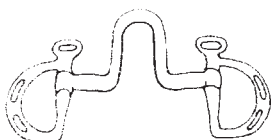

Excessive port

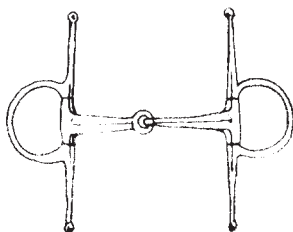

Triangular mouth

2. In reference to mouthpieces, nothing may protrude below the mouthpiece (bar). Solid and broken mouthpieces may have a port no higher than 1½ inches. On broken mouthpieces only, connecting rings of 1¼ inches or less in diameter or a connecting flat bar of ⅜ to ¾ inch that lie flat in the horse's mouth are acceptable. All mouthpieces must be a minimum of ⅝ inch in diameter to be measured 1 inch in from the cheek or ring. Snaffle bit rings may be no larger than 4 inches in diameter. Any bit having a fixed rein requires use of a curb chain. Smooth round, oval or egg-shaped, slow twist, corkscrew, single twisted wire, and double twisted wire, and straight bar or solid mouthpieces with a maximum of 1½ inches high ports are allowed.
3. Saddles must be black and/or brown of traditional hunting or forward seat type; knee inserts on the skirt are optional.

Optional Equipment

1. Spurs of unrowelled type that are blunt, round, or that includes a smooth rolling rubber ball and no longer than 1 inch
2. Crops or bats
3. Gloves
4. English breast plate
5. Braiding of mane and/or tail in hunt style
6. Standing or running martingales in Working Hunter, Jumping, and Equitation Over Fences only
7. Protective boots, leg wraps, and bandages in Jumping, Hunt Seat Equitation on the Flat, and Hunt Seat Equitation Over Fences
8. Mechanical hackamores only in Jumping (class 69)

Hunter Under Saddle (Bridle Path Hack)

56 Pony Hunter Under Saddle (Bridle Path Hack)

(All ponies 52 inches and under), Jr. 8–13 (canter required)

This class is designed for junior members with ponies (52 inches and under). Rules of Hunter Under Saddle will apply.

57 Hunter Under Saddle (Bridle Path Hack), Jr. 8–11

58 Hunter Under Saddle (Bridle Path Hack), Jr. 12–13

59 Hunter Under Saddle (Bridle Path Hack), Sr. 14–15

60 Hunter Under Saddle (Bridle Path Hack), Sr. 16–18

1. The purpose of the hunter under saddle horse is to present or exhibit a horse with a bright, alert expression, whose gaits show potential of being a working hunter. Therefore, its gait must be free-flowing, ground covering, and athletic. Hunters under saddle should be suitable to purpose. Hunters should move with long, low strides reaching forward with ease and smoothness, be able to lengthen stride and cover ground with relaxed, free-flowing movement, while exhibiting correct gaits that are of the proper cadence. The quality of the movement and the consistency of the gaits is a major consideration. Horses should be obedient, have a bright expression with alert ears, and respond willingly to the rider with light leg and hand contact. Horses should be responsive and smooth in transition. When asked to extend the trot or hand gallop, they should move out with the same flowing motion. The poll should be level with or slightly above the withers to allow proper impulsion behind. The head position should be slightly in front of or on the vertical.

2. This class will be judged on performance, condition, and conformation. Maximum credit will be given to the flowing, balanced, willing horse.
3. Horses to be:
 - a. shown under saddle, not to jump
 - b. shown at a walk, trot, and canter both ways of the ring. Horses should back easily and stand quietly.
 - c. reversed to the inside away from the rail
4. Horses may be asked to change to canter from the flat-footed walk or trot, at the judge's discretion. They may also be asked to lengthen their stride at the walk, trot, or canter one or both ways of the ring. An extension is an obvious lengthening of the stride with a slight increase of pace while exerting less effort and appears smooth to ride.
5. Faults to be scored according to severity:
 - a. Quick, short, or vertical strides
 - b. Being on the wrong lead and/or wrong diagonal at the trot
 - c. Breaking gait
 - d. Excessive speed at any gait
 - e. Excessive slowness at any gait; loss of forward momentum
 - f. Failure to take the appropriate gait when called for
 - g. Head carried too high
 - h. Head carried too low (such that poll is below the withers)
 - i. Overflexing or straining neck in head carriage so the nose is carried behind the vertical
 - j. Excessive nosing out
 - k. Failure to maintain light contact with horse's mouth
 - l. Stumbling
 - m. Horse appears sullen, dull, lethargic, emaciated, drawn, or overly tired
 - n. Consistently showing too far off the rail
6. At the option of the judge, all or only the top 12 horses may be required to hand gallop, one or both ways of the ring. Never more than 12 horses will hand gallop at one time. At the hand gallop, the judge may ask the group to halt and stand quietly on a free (loosened) rein.
 - Walk: A natural, flat-foot, four-beat gait. The horse must move straight and true at the walk. The walk must be alert, with a stride of reasonable length in keeping with the size of the horse. Loss of forward rhythmic movement will be penalized.
 - Trot: A two-beat gait comprising long, low, ground-covering, cadenced, and balanced strides. Smoothness is more essential than speed. The knees should remain relatively flat, exhibiting minimal flexion. Short, quick strides and/or extreme speed will be penalized. When asked to extend the trot, there should be a definite lengthening of the stride.
 - Canter: A three-beat gait; smooth, free-moving, relaxed, and straight on both leads. The stride should be long, low, and ground-covering. Overcollected four-beat canter and excessive speed will be penalized.

- Hand Gallop: A definite lengthening of the stride with a noticeable difference in speed. The horse should be under control at all times, and be able to halt in a smooth, balanced manner.

Hunter Under Saddle Walk/Trot

55 Hunter Under Saddle Walk/Trot, exhibitor 8–18

An exhibitor in class 55 may also enter classes 38–39, 45, 48-50, 53, 61, 64-65, 70, and 97, as well as Halter and Showmanship, provided the exhibitor and horse/pony meet the entry qualifications for each class. Entry in other classes is prohibited. The Hunter Under Saddle Walk/Trot class does not count toward high point awards. One sibling may ride a horse in Hunter Under Saddle Walk/Trot and another sibling may ride the same horse in Hunter Under Saddle.

1. The Hunter Under Saddle Walk/Trot class will be held at the state show with no district elimination (optional at district shows). Entries must be sent to Animal and Dairy Science Department, Attn: Dean Jousan, Box 9815, Mississippi State, MS 39762, by May 1 of the current year.
2. Hunters under saddle should be suitable to purpose. Hunters should move with long, low strides reaching forward with ease and smoothness, be able to lengthen stride and cover ground with relaxed, free-flowing movement, while exhibiting correct gaits that are of the proper cadence. The quality of the movement and the consistency of the gaits is a major consideration. Horses should be obedient, have a bright expression with alert ears, and respond willingly to the rider with light leg and hand contact. Horses should be responsive and smooth in transition. The poll should be level with or slightly above the withers to allow proper impulsion behind. The head position should be slightly in front of or on the vertical.
3. This class will be judged on performance, condition, and conformation. Maximum credit will be given to the flowing, balanced, willing horse.
4. Horses to be:
 - a. shown under saddle, not to jump
 - b. shown at a walk and trot both ways of the ring. Horses should back easily and stand quietly.
 - c. reversed to the inside away from the rail
5. Faults to be scored according to severity:
 - a. Quick, short, or vertical strides
 - b. Being on the wrong lead and/or wrong diagonal at the trot
 - c. Breaking gait
 - d. Excessive speed at any gait
 - e. Excessive slowness at any gait; loss of forward momentum
 - f. Failure to take the appropriate gait when called for
 - g. Head carried too high
 - h. Head carried too low (such that poll is below the withers)
 - i. Overflexing or straining neck in head carriage so the nose is carried behind the vertical
 - j. Excessive nosing out
 - k. Failure to maintain light contact with horse's mouth

- l. Stumbling
- m. Horse appears sullen, dull, lethargic, emaciated, drawn, or overly tired
- n. Consistently showing too far off the rail
 - Walk: A natural, flat-foot, four-beat gait. The horse must move straight and true at the walk. The walk must be alert, with a stride of reasonable length in keeping with the size of the horse. Loss of forward rhythmic movement will be penalized.
 - Trot: A two-beat gait comprising long, low, ground-covering, cadenced, and balanced strides. Smoothness is more essential than speed. The knees should remain relatively flat, exhibiting minimal flexion. Short, quick strides and/or extreme speed will be penalized. When asked to extend the trot, there should be a definite lengthening of the stride.

Hunt Seat Equitation on the Flat

61 Hunt Seat Equitation Walk/Trot exhibitors 8-18

An exhibitor in class 61 may also enter classes 38–39, 45, 48-50, 53, 55, 64-65, 70, and 97, as well as Halter and Showmanship, provided the exhibitor and horse/pony meet the entry qualifications for each class. Entry in other classes is prohibited. The Hunt Seat Equitation Walk/Trot class does not count toward high point awards. One sibling may ride a horse in Hunt Seat Equitation Walk/Trot and another sibling may ride the same horse in Hunt Seat Equitation.

1. The Hunt Seat Equitation Walk/Trot class will be held at the state show with no district elimination (optional at district shows). Entries must be sent to Animal and Dairy Science Department, Attn: Dean Jousan, Box 9815, Mississippi State, MS 39762, by May 1 of the current year.
2. All rules for classes 62–63 apply for Hunt Seat Equitation Walk/Trot class 61 except that each horse must show the two gaits (walk and trot) as part of its work.

62 Hunt Seat Equitation, Jr. exhibitors 8–13

63 Hunt Seat Equitation, Sr. exhibitors 14–18

1. General

Hunt Seat Equitation on the Flat is an evaluation based on the ability of riders to perform various maneuvers in harmony with their horses. The communication between horse and rider should be subtle. Equitation is judged on the rider and his or her effect on the horse. Hunt Seat Equitation on the Flat provides a base for a natural progression to over-fence classes. The poll should be level with, or slightly above the withers to allow proper impulsion behind. The head should not be carried behind the vertical, giving an intimidated appearance, or be excessively nosed out, giving a resistant appearance.

2. Pattern

It is mandatory that the judge post the pattern at least 1 hour before the beginning of the class. The pattern should be designed so the majority of exhibitors can perform it in a reasonable amount of time (fewer than 60 seconds). All patterns must include a trot, canter, and back. Horses' gaits are to be ridden with the same cadence and speed, as you would see in Hunter Under Saddle. All ties will be broken at the discretion of the judge. Failure to complete the pattern will not be a disqualification, but will be scored accordingly. Riders will not be required to jump.

3. Class Procedure

Exhibitors may be worked individually from the gate or they may all enter at once, but a working order must be drawn, regardless. The entire class, or only the finalists, must work at all three gaits at least one direction of the arena. Rail work can be used to break ties and possibly adjust placings. Individual works may be composed of any of the following maneuvers:

- a. Walk
- b. Sitting trot
- c. Extended trot
- d. Posting trot
- e. Canter
- f. Circles
- g. Figure eight
- h. Halt
- i. Back
- j. Sidepass
- k. Address reins
- l. Demonstrate change of diagonal
- m. Serpentine (trot or canter)
- n. Turn on haunches or forehand: A turn on forehand to the right is accomplished by moving haunches to the left. A forehand turn to the left is accomplished by moving the haunches to the right.
- o. Leg yield: When performing a leg yield, the horse should move forward and lateral in a diagonal direction with the horse's body straight with a slight flexion of the head in the opposite direction of lateral movement. When a horse yields to the right, the head is slightly (just to see the eye of the horse) to the left. A horse yielding to the left, the head is slightly flexed to the right.
- p. Flying or simple change of lead

4. Basic Position

To mount, take up reins in left hand and place hand on withers. Grasp stirrup leather with right hand and insert left foot in stirrup and mount. To dismount, rider may either step down or slide down. The size of the rider must be taken into consideration.

- a. Hands should be over and in front of the horse's withers, knuckles 30 degrees inside the vertical, hands slightly apart and making a straight line from horse's mouth to rider's elbow. Method of holding reins is optional, and bight of reins may fall on either side. However, all reins must be picked up at the same time.
- b. The eyes should be up and shoulders back.
- c. Toes should be at an angle best suited to rider's conformation; heels down, calf of leg in contact with horse.
- d. Iron should be on the ball of the foot. Iron or stirrup leather may not be connected by string or any other material to the girth.
- e. Appropriate English attire must be worn. Clothes and person are to be neat and clean. The use of any type of artificial aid or magnetic device will result in disqualification.
- f. Position in Motion

- › Walk: Should be a four-beat gait with the rider in a vertical position with a following hand.
- › Posting trot: Figure eight at trot, demonstrating change of diagonals. At left diagonal, rider should be sitting in the saddle when left front leg is on the ground; at right diagonal, rider should be sitting in the saddle when right front leg is on the ground; when circling clockwise at a trot, rider should be on left diagonal; when circling counter-clockwise, rider should be on right diagonal. The rider should close his or her hip angle to allow the torso to follow the horizontal motion of the horse. The upper body should be inclined about 20 degrees in front of the vertical.
- › Sitting trot and canter: At the sitting trot the upper body is only slightly in front of the vertical. At the canter the body should be positioned slightly more in front of the vertical. As the stride is shortened, the body should be in a slightly more erect position.
- › Two-point position: The pelvis should be forward but relaxed, lifting the rider's weight off the horse's back and transferring the weight through the rider's legs. In this position, the two points of contact between horse and rider are the rider's legs. Hands should be forward, up the neck, not resting on the neck.
- › Hand gallop: A three-beat, lengthened canter ridden in two-point position. The legs are on the horse's sides while the seat is held out of the saddle. When at the hand gallop, the rider's angulation will vary somewhat as the horse's stride is shortened and lengthened. A good standard at a normal hand gallop should be about 30 degrees in front of the vertical.

Scoring: Exhibitors are to be scored from 0 to infinity, with 70 denoting an average performance. Patterns will be divided into 6 to 10 maneuvers, as specified by the judge, and each maneuver will be scored from +3 to -3 with ½ point increments acceptable that will be added or subtracted from 70. Maneuver scores should be determined independent of penalties, and should reflect equal consideration of both performance of the exhibitor's pattern and the equitation form and effectiveness of the exhibitor to result in the following scores: +3 Excellent, +2 Very Good, +1 Good, 0 Average or Correct, -1 Poor, -2 Very Poor, -3 Extremely Poor. Exhibitors overall equitation form and effectiveness should also be scored from 0 to 5 with 0 to 2 Average, 3 Good, 4 Very Good, 5 Excellent. Exhibitors should also be judged on the rail, and their pattern score and/or ranking may be adjusted as appropriate.

An exhibitor should be penalized in the pattern independent of maneuver scores and deducted from the final score as follows:

Three points

- Break of gait at the walk or trot up to 2 strides
- Over or under turn from ¼ to ¼ turn
- Tick or hit of cone
- Missing a diagonal up to 2 strides in the pattern or on the rail

Five points

- Not performing the specific gait or not stopping within 10 feet (3 meters) of designated location
- Obviously looking down to check leads or diagonals
- Missing a diagonal for more than 2 strides in the pattern or on the rail

- Incorrect lead or break of gait at the canter (except when correcting an incorrect lead)
- Complete loss of contact between rider's hand and the horse's mouth
- Break of gait at walk or trot for more than 2 strides
- Loss of iron
- Head carried too low and/or clearly behind the vertical while the horse is in motion, showing the appearance of intimidation

Ten points

- Loss of rein
- Use of either hand to instill fear or praise while on pattern or during rail work
- Holding saddle with either hand
- Blatant disobedience including kicking, pawing, bucking, and rearing

Disqualifications (should not be placed)

- Failure by exhibitor to wear correct number in visible manner
- Willful abuse
- Excessive schooling or training
- Fall by horse or rider
- Illegal use of hands on reins
- Use of prohibited equipment
- Knocking over the cone, going off pattern, or working on wrong side of cone
- Failure to follow pattern correctly, including failure to ever execute correct lead or gait where called for overturning more than ¼ of prescribed turn

Ponies Entered in Over Fences Classes

All horses qualifying for the state horse show must enter and pay all fees within 30 minutes of the conclusion of the last state qualifying class of each day. Any exhibitor who does not pay their entry fees within 30 minutes of the last qualifying class each day will forfeit the right to compete at the state horse show in the class or classes that they qualified in that day. Alternates to fill open slots will begin immediately following the 30-minute time limit and will continue for an additional 30 minutes. Books are closed each day at the district horse show. No substitutions or additions will be made after the district show books have been closed. It is the exhibitor's responsibility to see that all entries and fees are properly made and paid at the appropriate time.

Cross Rails

66 Cross Rails, exhibitors 8–18

1. The Cross Rails class will be held at the state show with no district elimination (optional at district shows). Entries must be sent to Animal and Dairy Science Department, Attn: Dean Jousan, Box 9815, Mississippi State, MS, 39762 by May 1 of the current year.
2. Exhibitors who enter the Cross Rails class can not enter other over fences classes.
3. A horse may not be entered in other over fences classes but can be entered in other flat classes.
4. The rules for Working Hunter (class 67) will be followed for this class except for fence height (Cross Rails maximum fence height is 18 inches).

5. Cross Rails is designed to be an introduction to Over Fences Classes where ponies/horses are expected to trot some of the course. It is suggested that riders approach jumps at a trot. Riders may or may not canter out of the jump or line of jumps. Riders who canter the whole course will be penalized.
6. The Cross Rails class does not count toward high point awards.

Working Hunter

67 Working Hunter, exhibitors 8–18

1. The Working Hunter class will be held at the state show with no district elimination (optional at district shows). Entries must be sent to Animal and Dairy Science Department, Attn: Dean Jousan, Box 9815, Mississippi State, MS 39762, by May 1 of the current year.
2. The working hunter is a representative of the type of horse used in the hunt field. He should possess manners, jumping ability, style, pace, and quality. The working hunter must be able to demonstrate his ability to furnish the rider with a smooth, comfortable, and safe ride.
3. All horses must be serviceably sound. Horses must be placed on performance before consideration for soundness. Upon completing the last fence of the course, horses must be trotted in a circle to evaluate soundness. Any horse showing lameness, broken wind, or impairment of vision will be refused an award at the judge's discretion.
4. Each horse will individually negotiate a course consisting of at least eight jumps with a minimum of four obstacles. One change of direction is mandatory. The course diagram must be posted 1 hour before the class is called. Judging will start when the horse enters the arena and end when the horse leaves the arena.
5. Maximum height of fences will be as follows:
 - Small/medium ponies: 13 and under hands (1 foot 6 inches to 2 feet 0 inches)
 - Large ponies: over 13 to 14.2 hands (2 feet 0 inches to 2 feet 6 inches)
 - Hunter horses: over 14.2 hands (2 feet 3 inches to 2 feet 9 inches)
6. Management should provide at least one practice jump. This jump should be in a warm-up ring or area.
7. Jumps to be used in the jumping classes may be selected from the following list but will not be limited to this list:
 - Brush
 - Post and rail
 - In and out (post and rails spaced 24 to 26 feet)
 - Gate
 - Chicken coop
 - Stone wall
 - Oxer (must not be square; it is recommended that the back element be 3 to 6 inches higher)
8. When designing a hunt course, the jumps should be spaced a minimum of 48 feet apart; but all intervals must be multiples of 12 feet (for example, 48 feet and 60 feet apart from the point of landing to the point of takeoff in the next jump). The distance of takeoff or landing from the jump is usually equal to the height of the jump to 1½ times the height of the jump (for example, for a 3-foot fence, the takeoff point would be from 3 to 4½ feet from the fence).

9. Scoring:
 - a. To be judged on manners, way of going, and style of jumping. Horses will be credited with maintaining an even hunting pace that covers the course with free-flowing strides. Preference will be given to horses with correct jumping style that meet fences squarely, jumping at the center of fence. Judges will penalize unsafe jumping and bad form over fence, whether touched or untouched, including twisting. Incorrect leads around the ends of the course or cross-cantering will be penalized, as well as excessive use of crop. In and outs (one or two strides) will be taken in the correct number of strides or be penalized. Any error that endangers the horse and/or its rider, particularly refusals or knockdowns, will be heavily penalized.
 - b. Scoring will be on a basis of 0–100, with an approximate breakdown as follows:
 - 90–100: An excellent performer and good mover that jumps the entire course with cadence, balance, and style.
 - 80–89: A good performer that jumps all fences reasonably well; an excellent performer that commits one or two minor faults.
 - 70–79: The average, fair mover that makes no serious faults but lacks the style, cadence, and good balance of the scoper horses; the good performer that makes a few minor faults.
 - 60–69: Poor movers that make minor mistakes; fair or average movers that have one or two poor fences but no major faults or disobediences.
 - 50–59: A horse that commits one major fault, such as a hind knockdown, refusal, trot, cross canter, or leg drop.
 - 30–49: A horse that commits two or more major faults, including front knockdowns and refusals, or jumps in a manner that otherwise endangers the horse and/or rider.
 - 10–29: A horse that avoids elimination but jumps in such an unsafe and dangerous manner as to preclude a higher score.
10. The following will result in elimination (should not be placed).
 - A total of three disobediences that can include any of the following: refusal, stop, run out, or extra circle.
 - Jumping an obstacle before it is reset.
 - Bolting from the arena.
 - Off course.
 - Deliberately addressing an obstacle.
 - Failure to trot the horse in a small circle on a loose rein for soundness, after jumping the last fence, while still mounted and prior to leaving the arena.

Equitation Over Fences

68 Equitation Over Fences Exhibitors 8–18

1. The Equitation Over Fences class will be held at the state show with no district elimination. Entries must be sent to Animal and Dairy Science Department, Attn: Dean Jousan, Box 9815, Mississippi State, MS 39762, by May 1 of the current year.
2. The purpose of this event is to evaluate amateur and youth riders' correctness and ability over the fences. This class should be judged on the precision of riding ability while executing the jumps. The class objective is to judge the rider's ability over the fences, not the horse. Only the effect the rider has on a horse is to be considered.

How a rider elects to ride the course, the pace, and the approach to the jumps are used to evaluate the rider's judgment and ability.

3. Position. Refer to Hunt Seat Equitation on the Flat, Basic Position.
4. Course requirements.
 - At least four obstacles are required, and horses must jump a minimum of six fences.
 - At least one change of direction is required.
 - Maximum fence height will correspond to those listed in Working Hunter rules.
 - It is recommended that show management offer this class after its corresponding working hunter class.
5. Class Routine. The exhibitor is being judged as soon as he/she enters the arena.
 - Exhibitors have the option of entering the arena at any gait (unless otherwise stated on the course), making transition to canter from halt, and walking or trotting before approaching the first fence.
 - Each competitor may circle once before approaching the first obstacle, then proceed around the course, keeping an even pace throughout. If a rider steps into the obvious wrong lead for one or two strides only before or on the courtesy circle, it is noted on the score sheet, which may be used as a tie-breaker in the event of a ride of equal quality and score.
 - Rider must obtain correct lead to properly turn around end of arena before breaking into final trot circle. The class is not over until the exhibitor trots a circle and walks out of the ring. Riders should leave the arena at a walk unless otherwise instructed.
 - Except for refusals and knockdowns, jumping faults of the horse are not to be considered unless it is the result of the rider's ability. If a refusal occurs in a double or triple, competitors must re-jump all obstacles in the combination. In case of knockdowns, the judge will determine a base score for each competitor's performance. A knockdown penalty of 4 points per obstacle will be deducted from base score.
 - In cases of broken equipment or loss of shoe, competitor must continue or be eliminated.
6. The final riders may be required to work on the rail to determine the final placing.
7. Scoring may be on a basis of 0–100, with an approximate breakdown as follows.

90–100: Excellent equitation, position, and presentation; meets all fences squarely and at proper distance. Rider uses all options to his or her advantage.

80–89: Minor equitation faults (i.e., long, weak distance, deep distance, one step landing at counter-canter). Rider still maintains a quality ride.

70–79: More problems occur; equitation suffers (i.e., rounded shoulders, heels are not down, hands incorrect, lacks the style and presence). One major fence problem (i.e., chip with a ride up the neck, or discreet swap out, jumping off one side of jump). No dangerous fences; not a flowing course.

60–69: Major equitation faults, poor body position, loose legs and seat; failure to obtain or maintain trot to a trot fence approach; two or three misses at the fence.

40–59: Breaking to a trot while on course, counter-canter, or cross-canter at ends of arena; missed lead changes, loss of stirrup, dropping a rein, extra stride in combination.

10–39: Rider avoids elimination; one or two refusals, knockdowns, dangerous fences.

8. The following will result in elimination (should not be placed):

- three cumulative refusals
- off course

If elimination occurs during a ride-off, the competitor is placed last of all those chosen for the ride-off.

9. Major faults include:

- a refusal
- loss of stirrup
- trotting while on course when not part of a test
- loss of reins
- incorrect diagonal
- Outside assistance will be penalized at the judge's discretion.

Jumping

69 Jumping, exhibitors 8–18

1. The Jumping class will be held at the state show with no district elimination (optional at district shows). Entries must be sent to Animal and Dairy Science Department, Attn: Dean Jousan, Box 9815, Mississippi State, MS 39762, by May 1 of the current year.
2. The jumper's task is solely to jump, and his/her score is based entirely on his/her performance alone. Jumpers are scored and placed on a mathematical basis and on penalty faults that include disobediences, falls, and knockdowns. Time will be used along with cumulative faults in jump off rounds.
3. Each horse will negotiate a course consisting of at least four different obstacles and make a minimum of eight jumps. Refer to Working Hunter number 7 for types of jumps.
4. A starting line at least 12 feet in front of the first obstacle and a finish line at least 24 feet beyond the last obstacle must be indicated by markers (at least 12 feet apart) at each end of the lines. Horses must start and finish by passing between markers.
5. Horses and ponies will compete in the same class. The height of all fences will be a minimum of 3 feet. Fences must be set at the required height indicated, within a 2-inch variance.
6. At least half of the jumps must be raised no fewer than 3 inches, no more than 6 inches for each additional go-round. The first jump in each round should be more than the minimum height used in the elimination round.
7. The course may be changed and/or jumps eliminated in each additional round. Courses used in additional rounds will be announced to all riders.
8. Jumpers are scored on a mathematical basis and penalty faults, which include knockdowns, disobediences, and faults.
 - a. First disobedience anywhere on course—four faults.

- b. Second cumulative disobedience anywhere on course—four faults.
- c. In cases of broken equipment, the rider may either continue without penalty or stop and correct difficulty, in which case he/she will be penalized four points.
- d. In case of loss of shoe, rider may continue without penalty or be eliminated.
- e. Knockdown: an obstacle is considered knocked down and four faults assessed, when a horse or rider, by contact:
 - Lowers any part thereof which establishes the height of the obstacle or the height of any element of a spread obstacle even when the falling part is arrested in its fall by any portion of the obstacle; or
 - Moves any part thereof which establishes the height of the obstacle so it rests on a different support from the one on which it was originally placed;
 - Knocks down an obstacle, standard wing, automatic timing equipment, or other designated markers on start and finish lines.
 - If an obstacle falls after the horse leaves the ring, it will not be considered a knockdown.
- f. Jumping an obstacle before crossing start line unless said obstacle is designated as a practice obstacle, or after crossing the finish line, whether forming part of the course or not
- g. Off course
- h. Rider and/or horse leaving the arena before finishing the course (penalized at any time the horse is in the ring)
- i. Excessive use of a whip, rope, crop, bat, or reins anywhere on the horse

Dressage

70 Introductory Dressage (no canter), Jr. and Sr. exhibitors 8–18

71 Dressage, Jr. 8–13

72 Dressage, Sr. 14–18

An exhibitor in class 70 may also enter classes 37-38, 44, 47-49,

52, 55, 61, 64-65, and 97, as well as Halter and Showmanship, provided the exhibitor and horse/pony meet the entry qualifications for each class. Entry in other classes is prohibited. The Introductory Dressage class does not count toward high point awards. One sibling may ride a horse in Introductory Dressage (no canter) and another sibling may ride the same horse in Dressage.

Personal Appointments

Exhibitors should wear hunt coats of traditional colors, such as navy, dark green, gray, black, or brown. Maroon and red are inappropriate. Shirts should be conservative in color with a choker/rat catcher, snap choker, or tie. Breeches are to be of traditional shades of buff, khaki, canary, light gray, or rust with high English boots or paddock (Jodhpur) boots of black or brown. Riders are allowed to wear black or brown half chaps in English classes. A black, navy blue, or brown hard hat with fastened chinstrap is mandatory for all over-fence classes and is recommended for all classes in the Hunter Division.

ASTM/SEI helmets are required (see rule 34 on page 15). Gloves, spurs of the unrowelled type, and crops or bats are optional. Dressage whips are optional, but it must not exceed 47.2 inches (120 cm), including lash. Hair must be neat and contained (as in a net or braid). Judges must penalize contestants who do not conform; however, judges, at their discretion, may authorize adjustments to attire due to weather-related conditions.

Tack

To be ridden in a snaffle with a smooth mouthpiece with or without a drop, flash, or figure eight noseband. Tack may be inspected before the competition. Dressage whips are optional. Contestant will be disqualified if unauthorized tack is not removed. Martingales are not allowed. Any English-type saddle may be used (that is, dressage, forward seat, flat, or cut back).

1. Dressage will be held at the state show with no district elimination (optional at district shows). Entries must be sent to Animal and Dairy Science Department, Attn: Dean Jousan, Box 9815, Mississippi State, MS 39762, by May 1 of the current year.
2. These classes are open to current 4-H members 8–18 years of age, depending on the age restriction for each class. All contestants and horses must be eligible according to the current year's Mississippi 4-H Horse Show Classes, Rules, and Regulations.
3. The purpose is to test the rider and horse on the basic principles of dressage competition.

Disobediences

- a. Refusal. When a horse stops in front of an obstacle (whether or not the obstacle is knocked down or altered), it is a refusal unless the horse then immediately jumps the obstacle without backing one step. If horse takes one step backward, it is a refusal.
 - After a refusal, if horse is moved toward the obstacle but does not attempt to jump, it is considered another refusal.
 - In the case of a refusal on an in-and-out jump, the horse may return to the start of the in-and-out sequence and rejump previous elements as well as following elements.
- b. Run-out: A run-out occurs when a horse evades or passes the obstacle to be jumped; jumps an obstacle outside its limiting markers; or when the horse or rider knocks down a flag, standard, wing, or other element limiting the obstacle (without obstacle being jumped).
 - Loss of forward movement: Failure to maintain trot, canter, or gallop after crossing starting line, except when it is a refusal or a run-out, or when due to uncontrollable circumstances, such as when an obstacle is being reset.
 - Unnecessary circling on course: Any form of circle or circles, whereby the horse crosses its original track between two consecutive obstacles anywhere on course, except to retake obstacle after refusal or run-out.

Elimination (should not be placed)

- a. Third cumulative disobedience anywhere on course
- b. Jumping an obstacle before it is reset, or without waiting for signal to proceed
- c. Starting before judges signal to proceed
- d. Failure to enter ring within 1 minute of being called
- e. Failure to cross the starting line within 45 seconds after an audible signal to proceed

4. Approximately 5–8 minutes will be allowed for each test. This includes warm-up time before the riding test. Specific time limit to be determined based on test used.
5. Rider must enter within 1 minute after whistle or bell has been sounded.
6. For class 70 Introductory Dressage (no canter), the test to be used will be selected from the Introductory Level Tests A and B (Walk/Trot) from the United States Dressage Federation. The introductory collective marks follow the Introductory Level Tests A–B in this rule book.
7. The Dressage test movements for classes 71 and 72 will be determined on an annual basis. These movements will be taken from the United States Equestrian Federation, Inc. The test to be used will be selected from the 2019 Training Level Tests 1–3. The training level collective marks follow the Training Level Tests 1–3 in this rule book.
8. Scoring: Each movement of the test and collective marks (gaits, impulsion, submission, and rider) are scored on a numerical scale of 0–10. Coefficients of two or three are applied to selected movements and collective marks in each test. The score (0–10) for selected movements and all collective marks is then multiplied by the coefficient listed in that row of the table. The total score for each movement and collective mark is then tabulated to give the total points earned by the exhibitor. In the title of each test, the total number of possible points is given for that test. Below is a breakdown of the numerical scoring used:

| | |
|----------------|--|
| 10 Excellent | 4 Insufficient |
| 9 Very good | 3 Fairly bad |
| 8 Good | 2 Bad |
| 7 Fairly good | 1 Very bad |
| 6 Satisfactory | 0 Not performed, or fall of horse or rider |
| 5 Sufficient | |
9. Penalties: First error, two points; second error, four points; third error, elimination.
10. Arena size for this competition may be 20 by 40 meters or 20 by 60 meters.

Large Dressage Arena 20m × 60m

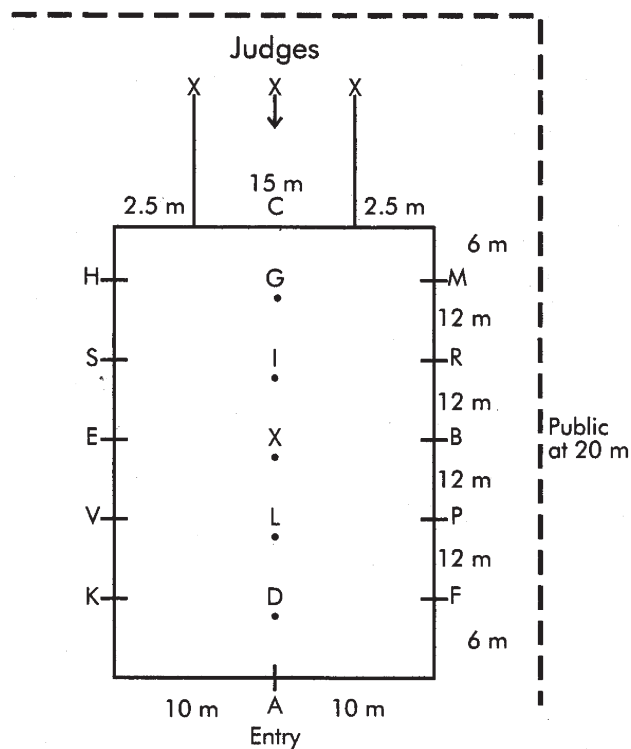

- AC –Center Line
- KM, FH –Diagonal Lines Across the Arena
- X –Center
- A –Entrance and Exit for all Tests

Small Dressage Arena 20m × 40m

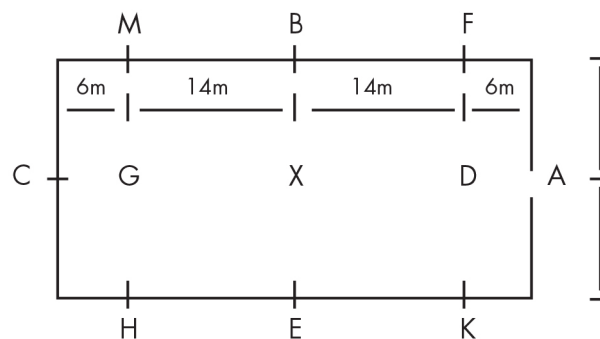

2023 USDF INTRODUCTORY LEVEL – TEST A

WALK—TROT

REQUIREMENTS:
Free walk
Medium walk
Working trot rising
20 meter circle
Halt through walk

PURPOSE: To introduce the rider and/or horse to the sport of dressage, confirming that they are beginning to develop an understanding of correct dressage basics. The horse should be ridden freely forward in a steady tempo and clear rhythm, accepting contact with the bit. An understanding of test accuracy and geometry should be demonstrated.

NO.

| | | TEST | DIRECTIVE IDEAS | POINTS | COEF | TOTAL | REMARKS |
|----|-----------------------|---|---|--------|------|-------|---------|
| 1. | A Between X & C | Enter, working trot rising Medium walk | Regularity, quality of trot; straightness, willing, calm transition. Regularity, quality, of walk | | | | |
| 2. | C M | Track right Working trot rising | Bend and balance; willing, calm transition | | | | |
| 3. | A | Circle right 20 meters, working trot rising | Regularity; shape and size of circle; bend; balance | | | | |
| 4. | K-X-M | Change rein, working trot rising | Regularity of trot; straightness; bend and balance in corner | | | | |
| 5. | C | Circle left 20 meters, working trot rising | Regularity; shape and size of circle; bend; balance | | | | |
| 6. | Between C & H | Medium walk | Willing, calm transition; regularity, quality | | | | |
| 7. | H-X-F | Free walk | Regularity, reach and ground cover with over track of free walk allowing complete freedom to stretch the neck forward and downward | | | | |
| 8. | F-A A | Medium walk Down centerline | Regularity, quality, willing, calm transition, bend and balance in turn Straightness on centerline. | | | | |
| 9. | X | Halt and salute | Straightness; attentiveness; immobility (min. 3 seconds) | | | | |

Leave arena in free walk. Exit at A.

2023 USDF INTRODUCTORY LEVEL – TEST B

REQUIREMENTS:
 Free walk
 Medium walk
 Working trot rising
 20 meter circle
 Halt through walk

PURPOSE: To introduce the rider and/or horse to the sport of dressage, confirming that they are beginning to develop an understanding of correct dressage basics. The horse should be ridden freely forward in a steady tempo and clear rhythm, accepting contact with the bit. An understanding of test accuracy and geometry should be demonstrated.

NO.

| | | TEST | DIRECTIVE IDEAS | POINTS | COEF | TOTAL | REMARKS |
|----|------------------|--|--|--------|------|-------|---------|
| 1. | A X | Enter working trot rising. Halt through medium walk Salute - Proceed working trot rising | Regularity, quality of trot; willing, calm transitions; straightness; attentiveness; immobility (min. 3 seconds) | | | | |
| 2. | C | Track left, working trot rising | Regularity; bend and balance in turn and corner | | | | |
| 3. | E | Circle left 20 meters, working trot rising | Regularity; shape and size of circle; bend; balance | | | | |
| 4. | Between K & A | Medium walk | Willing, calm transition; regularity, quality | | | | |
| 5. | F-E | Free walk | Regularity, reach, and ground cover with overtrack of free walk allowing complete freedom to stretch the neck forward and downward | | | | |
| 6. | E-H | Medium walk | Willing, calm transition; regularity, quality, overtrack | | | | |
| 7. | Between H & C | Working trot rising | Willing, calm transition; regularity of trot; bend and balance in corner | | | | |
| 8. | B | Circle right 20 meters, working trot rising | Regularity; shape and size of circle; bend; balance | | | | |
| 9. | A X | Down centerline Halt through medium walk, Salute | Bend and balance in turn; straightness; regularity of trot; willing, calm transition; straightness; attentiveness; immobility (min. 3 seconds) | | | | |

Leave arena in free walk. Exit at A.

2023 USEF TRAINING LEVEL TEST 1

PURPOSE

To confirm that the horse demonstrates correct basics, by showing suppleness both laterally and longitudinally, moving freely forward in a clear rhythm with a steady tempo, and readily accepting contact with the bit. Correct geometry and lines of travel should be shown.

All trot work may be ridden sitting or rising, unless otherwise stated.
Halts may be through the walk.

READER PLEASE NOTE: Anything in parentheses should not be read.

INTRODUCE

Working trot; working canter;
medium walk; free walk;
20m circles in trot and canter

ENTRY NO:

Conditions:

ARENA SIZE: Standard or Small
AVERAGE RIDE TIME: 5:00 (Std.) or 4:00 (Small)
(from entry at A to final halt)
Suggested to add at least 2 min. for scheduling purposes

MAXIMUM PTS: 260

| | TEST | DIRECTIVES | POINTS | COEF | TOTAL | REMARKS |
|-----|------------------|---|--|------|-------|---------|
| 1. | A X | Enter working trot Halt, salute Proceed working trot | Regularity and quality of trot; willing, calm transitions; straightness; attentiveness; immobility (min. 3 seconds) | | | |
| 2. | C E | Track left Circle left 20m | Regularity and quality of trot; shape and size of circle; bend; balance | 2 | | |
| 3. | A | Circle left 20m developing left lead canter in first quarter of circle | Willing, calm transition; regularity and quality of gaits; shape and size of circle; bend; balance | | | |
| 4. | A-F-B | Working canter | Regularity and quality of canter; bend and balance in corner; straightness | | | |
| 5. | Between B & M | Working trot | Willing, calm transition; regularity and quality of gaits; straightness; bend and balance in corner | 2 | | |
| 6. | Between C & H | Medium walk | Willing, calm transition; regularity, quality, bend and balance in corner | 2 | | |
| 7. | E-F F | Change rein, free walk Medium walk | Regularity and quality of walks; reach, overtrack, and ground cover of free walk allowing complete freedom to stretch the neck forward and downward; straightness; willing, calm transitions | 2 | | |
| 8. | A | Working trot | Willing, calm transition; regularity and quality of trot; bend and balance in corner; straightness | | | |
| 9. | E | Circle right 20m | Regularity and quality of trot; shape and size of circle; bend; balance | 2 | | |
| 10. | C | Circle right 20m developing right lead canter in first quarter of circle | Willing, calm transition; regularity and quality of gaits; shape and size of circle; bend; balance | | | |
| 11. | C-M-B | Working canter | Regularity and quality of canter; bend and balance in corner; straightness | | | |
| 12. | Between B & F | Working trot | Willing, calm transition; regularity and quality of gaits; straightness; bend and balance in corner | 2 | | |
| 13. | A X | Down centerline Halt, salute | Bend and balance in turn; regularity and quality of trot; willing, calm transition; straightness; attentiveness; immobility (min. 3 seconds) | | | |

Leave arena at A in free walk.

2023 USEF TRAINING LEVEL TEST 2

PURPOSE

To confirm that the horse demonstrates correct basics, by showing suppleness both laterally and longitudinally, moving freely forward in a clear rhythm with a steady tempo, and readily accepting contact with the bit. Correct geometry and lines of travel should be shown.

All trot work may be ridden sitting or rising, unless otherwise stated.
Halts may be through the walk.

READER PLEASE NOTE: Anything in parentheses should not be read.

| | |
|------------------------|---|
| INTRODUCE | ENTRY NO: <input style="width: 100px;" type="text"/> |
| Stretch circle in trot | Conditions: ARENA SIZE: Standard or Small AVERAGE RIDE TIME: 5:30 (Std.) or 4:30 (Small) (from entry at A to final halt) <i>Suggested to add at least 2 min. for scheduling purposes</i> |
| | MAXIMUM PTS: 290 <input style="width: 100px;" type="text"/> |

| TEST | | DIRECTIVES | POINTS | COEF | TOTAL | REMARKS |
|--------------------------------|------------------------|--|--|------|-------|---------|
| 1. | A X | Enter working trot Halt, salute Proceed working trot | Regularity and quality of trot; willing, calm transitions; straightness; attentiveness; immobility (min. 3 seconds) | | | |
| 2. | C B | Track right Circle right 20m | Regularity and quality of trot; shape and size of circle; bend and balance | | | |
| 3. | K-X-M | Change rein | Regularity and quality of trot; straightness; bend and balance in corner | 2 | | |
| 4. | Between C & H | Working canter left lead | Willing, calm transition; regularity and quality of gaits; bend and balance in corner; straightness | 2 | | |
| 5. | E | Circle left 20m | Regularity and quality of canter; shape and size of circle; bend; balance | | | |
| 6. | Between E & K | Working trot | Willing, calm transition; regularity and quality of gaits; straightness; bend and balance in corner | | | |
| 7. | A Before A A | Circle left 20m rising trot, allowing the horse to stretch forward and downward while maintaining contact Shorten the reins Working trot | Forward and downward stretch over the back into a light contact, maintaining balance and quality of trot; bend; shape and size of circle; willing, calm transitions | | | |
| 8. | F F-E | Medium walk Change rein, medium walk | Willing, calm transition; regularity, overtrack, and quality of walk | 2 | | |
| 9. | E-M M | Change rein, free walk Medium walk | Regularity and quality of walks; reach, overtrack, and ground cover of free walk allowing complete freedom to stretch the neck forward and downward; straightness; willing, calm transitions | 2 | | |
| 10. | C | Working trot | Willing, calm transition; regularity and quality of trot; bend and balance in corner; straightness | | | |
| 11. | E | Circle left 20m | Regularity and quality of trot; shape and size of circle; bend; balance | | | |
| 12. | F-X-H | Change rein | Regularity and quality of trot; straightness; bend and balance in corner | 2 | | |
| 13. | Between C & M | Working canter right lead | Willing, calm transition; regularity and quality of gaits; bend and balance in corner; straightness | 2 | | |
| 14. | B | Circle right 20m | Regularity and quality of canter; shape and size of circle; bend; balance | | | |
| 15. | Between B & F | Working trot | Willing, calm transition; regularity and quality of gaits; straightness; bend and balance in corner | | | |
| 16. | A X | Down centerline Halt, salute | Bend and balance in turn; regularity and quality of trot; willing, calm transition; straightness; attentiveness; immobility (min. 3 seconds) | | | |
| Leave arena at A in free walk. | | | | | | |

2023 USEF TRAINING LEVEL TEST 3

PURPOSE

To confirm that the horse demonstrates correct basics, by showing suppleness both laterally and longitudinally, moving freely forward in a clear rhythm with a steady tempo, and readily accepting contact with the bit. Correct geometry and lines of travel should be shown.

All trot work may be ridden sitting or rising, unless otherwise stated.
Halts may be through the walk.

READER PLEASE NOTE: Anything in parentheses should not be read.

INTRODUCE

Changing of bend on a shallow loop, canter-trot transition on diagonal

ENTRY NO:

Conditions:

ARENA SIZE: Standard or Small
AVERAGE RIDE TIME: 5:30 (Std.) or 4:30 (Small)
(from entry at A to final halt)
Suggested to add at least 2 min. for scheduling purposes

MAXIMUM PTS: 250

| TEST | | DIRECTIVES | POINTS | COEF | TOTAL | REMARKS |
|------|--------------------|---|--|------|-------|---------|
| 1. | A X | Enter working trot Halt, salute Proceed working trot | Regularity and quality of trot; willing, calm transitions; straightness; attentiveness; immobility (min. 3 seconds) | | | |
| 2. | C H-X-K | Track left Slightly after H begin a single loop to X returning to the track slightly before K | Regularity and quality of trot; bend and balance in turns; shape and size of loop; changes of bend; balance | 2 | | |
| 3. | Between A & F | Working canter left lead | Willing, calm transition; regularity and quality of gaits; bend in corner; straightness | | | |
| 4. | B | Circle left 20m | Regularity and quality of canter; shape and size of circle; bend; balance | | | |
| 5. | H-X-F X | Change rein Working trot | Regularity and quality of gaits; willing, calm transition; straightness; bend in corner | | | |
| 6. | A | Medium walk | Willing, calm transition; regularity, quality | 2 | | |
| 7. | K-X-H H | Free walk Medium walk | Regularity and quality of walks; reach, overtrack, and ground cover of free walk allowing complete freedom to stretch the neck forward and downward; straightness; willing, calm transitions | 2 | | |
| 8. | C M-X-F | Working Trot Slightly after M begin a single loop to X returning to the track slightly before F | Regularity and quality of trot; shape and size of loop; changes of bend and balance | 2 | | |
| 9. | Between A & K | Working canter right lead | Willing, calm transition; regularity and quality of gaits; bend and balance in corner; straightness | | | |
| 10. | E | Circle right 20m | Regularity and quality of canter; shape and size of circle; bend; balance | | | |
| 11. | C | Working trot | Willing, calm transition; regularity and quality of trot | | | |
| 12. | B Before B B | Circle right 20m in rising trot allowing the horse to stretch forward and downward Shorten the reins Working trot | Forward and downward stretch over the back into a light contact, maintaining balance and quality of trot; bend; shape and size of circle; willing, calm transitions | 2 | | |
| 13. | A X | Down centerline Halt, salute | Bend and balance in turn; regularity and quality of trot; willing, calm transition; straight, attentive halt; immobile (min. 3 seconds) | | | |

Leave arena at A in free walk.

Speed Events

Rules and Regulations

1. The next horse to run in a speed class will enter the entrance alley (expo center outside gate), and horses must not begin their run until they are inside the expo center outside gate. Assistance (one person only) will be allowed inside the expo center outside gate and entrance alley but not beyond the arena gate.
2. When the rider begins a run in Speed Events, the arena gate will be open unless the exhibitor requests the arena gate be closed.
3. At the state show, a closed gate finish at the end of the alley will be used. The gate setup for speed events will consist of a V pattern with one entry gate and one exit gate in the alley with the option of an arena gate. The V pattern design will be patterned after NBHA. Requests to close the arena gate are permitted but must be made immediately before the start of the run. In the Stake Race, the arena gate will be closed once the horse enters the arena and will remain closed the entire run. Horse and rider will leave the arena through the exit gate after the run. The gate setup for speed events is for the state horse show only and is recommended for each district horse show.
4. Both the arena and back gates must be covered with a nonwhite tarp.
5. In speed events, it is permissible to make a circle prior to the start of the pattern as long as the rider does not cross the clocks.

Personal Appointments

Riders must wear boots and suitable clothing, including a shirt with a collar and long sleeves. Shirts must be tucked in and sleeves rolled down and fastened. Also, contestants competing in barrels, poles, and stakes classes **MUST WEAR** properly fitted equestrian helmets with fastened chin harnesses at all times when mounted on a horse on the show grounds. ASTM/SEI helmets are required (see rule 34 on page 15). It is the responsibility of the exhibitor or the parent, guardian, or trainer of exhibitor to ensure compliance. Contestants violating these rules will receive no time.

Tack

Western-type equipment must be used. Use of a mechanical hackamore or other types of bridles is optional. Stirrups, stirrup leathers, or any part of the fender should not be attached by any means to the cinch, breastplate, saddle, horse, or anywhere other than where it is normally attached to the saddle. No wire curbs, regardless of how they are taped, nor any chinstrap narrower than $\frac{1}{2}$ inch will be permitted. Chain curbs are permissible but must be of the flat variety with no twist. The use of approved chain mouthpieces is legal. Tie downs and running martingales are permitted in Speed Events. The mouthpiece must be at least $\frac{5}{16}$ inch in diameter. However, saw tooth or bicycle chain mouthpieces are illegal. No bare metal is allowed on any part of the horse's head. Protective boots, leg wraps, and bandages are allowed. The judge may prohibit the use of bits, shoes other than standard horseshoes, or equipment that may be considered severe or inhumane (electrical devices are prohibited).

No exhibitor may be tied, buckled, or fastened into the saddle in any manner or by any means during competition. (String, rubber bands, sandpaper, vet wrap, or other material designed to hold exhibitor's feet in the stirrups is prohibited.) See General Show Rules and Regulations number 32 for special needs situations. The judges or designated officials may disqualify a contestant for cruelty or abuse to a horse and for excessive use of bats, crops, whips, ropes, or hands in front of the cinch.

Pole Bending

73 Pole Bending–Pony (48 inches and under), Jr. 8–13

74 Pole Bending–Pony (over 48–52 inches), Jr. 8–13

75 Pole Bending (over 52 inches), Jr. 8–11

76 Pole Bending (over 52 inches), Jr. 12–13

77 Pole Bending (over 52 inches), Sr. 14–15

78 Pole Bending (over 52 inches), Sr. 16–18

Pole Bending Pattern

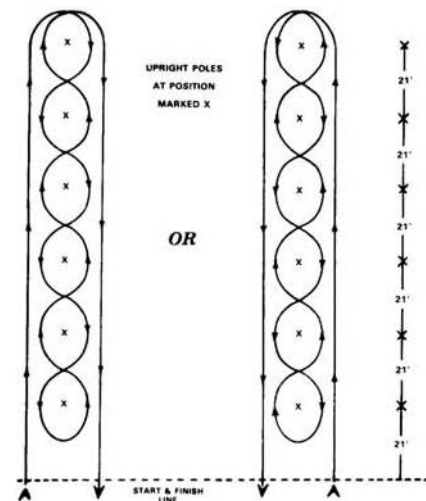

1. Pole Bending is a timed event. Each contestant will begin from a running start, and time will begin and end as the horse's nose crosses the start/finish line.
2. The Pole Bending pattern is to be run around six poles. Each pole is to be 21 feet apart, and the first pole is to be 21 feet from the starting line.
3. A horse may start either to the right or to the left of the first pole and then run the remainder of the pattern accordingly (see pattern).
4. Knocking over a pole will carry a 5-second penalty. Failure to follow the course will cause disqualification (e.g., completely stopping, backing up, wrong direction, etc.). A contestant may touch a pole with his or her hand in Pole Bending.
5. The judge or designated officials may disqualify a contestant for cruelty or abuse to a horse and for excessive use of a bat, crop, whip, rope, or hands in front of the cinch.
6. No exhibitor may be tied, buckled, or fastened into the saddle in any manner or by any means during competition. (String, rubber bands, sandpaper, vet wrap, or other material designed to hold exhibitor's feet in the stirrups is prohibited.) See General Show Rules and Regulations number 32 for special needs situations.

Barrel Racing

79 Barrel Racing—Pony (48 inches and under), Jr. 8–13

80 Barrel Racing—Pony (over 48–52 inches), Jr. 8–13

81 Barrel Racing (over 52 inches), Jr. 8–11

82 Barrel Racing (over 52 inches), Jr. 12–13

83 Barrel Racing (over 52 inches), Sr. 14–15

84 Barrel Racing (over 52 inches), Sr. 16–18

Barrel Racing Pattern

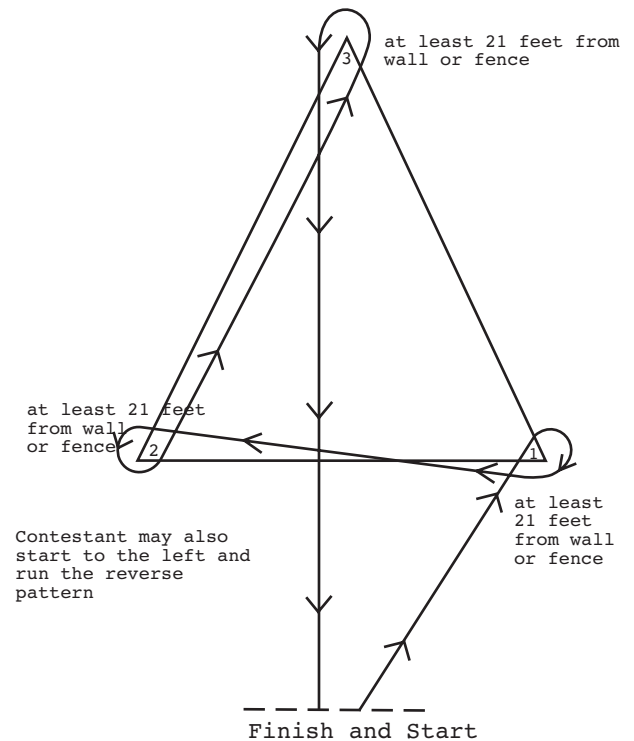

1. Barrel Racing is a timed event. For safety, a plastic barrel will be used.
2. Knocking over a barrel carries a 5-second penalty. Failure to follow the course will cause disqualification (completely stopping, backing up, wrong direction, etc.). A contestant may touch a barrel with his or her hands in Barrel Racing.
3. The course must be measured exactly. If the standard course is too large for the available space, then the pattern should be reduced until the pattern fits the arena, maintaining at least 21 feet from wall or fence.
4. The contestant is allowed a running start. At a signal from the starter, the contestant will run to barrel number 1, pass to the left of it, and complete an approximately 360-degree turn around it; then go to barrel number 2, pass to the right of it, and complete a slightly more than 360-degree turn around it; then go to barrel number 3, pass to the right of it, and do another approximately 360-degree turn around it; then sprint to the finish line, passing between barrels number 1 and 2. This barrel course may also be run to the left. For example, the contestants will start to barrel number 2, turning to left around this barrel, then to barrel number 1, turning to the right, then to barrel number 3, turning again to the right, followed by the final sprint to the finish line.
5. Timing will begin as soon as the horse's nose reaches the starting line and will be stopped when the horse's nose passes over the finish line.
6. The judge or designated officials may disqualify a contestant for cruelty or abuse to a horse and for excessive use of a bat, crop, whip, rope, or hands in front of the cinch.
7. No exhibitor may be tied, buckled, or fastened into the saddle in any manner or by any means during competition. (String, rubber bands, sandpaper, vet wrap, or other material designed to hold exhibitor's feet in the stirrups is prohibited.) See General Show Rules and Regulations number 32 for special needs situations.

Stake Race

85 Stake Race—Pony (48 inches and under), Jr. 8–13

86 Stake Race—Pony (over 48–52 inches), Jr. 8–13

87 Stake Race (over 52 inches), Jr. 8–11

88 Stake Race (over 52 inches), Jr. 12–13

89 Stake Race (over 52 inches), Sr. 14–15

90 Stake Race (over 52 inches), Sr. 16–18

Acceptable Stake Race Patterns

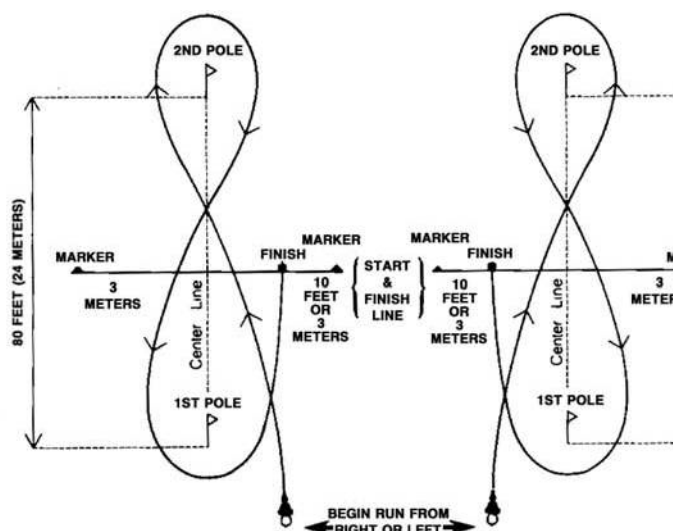

1. This is a timed event. Timing will begin as soon as the horse's nose reaches the starting line and will be stopped when the horse's nose passes over the finish line.
2. The contestant is allowed a running start and may begin the run from either the left or right side of the first pole. The contestant must run the Stake Race pattern depicted above. Start by crossing the center line between the upright markers, turn around the second pole, cross over the center line again between the markers, then around the first pole and run back across the finish line.
3. The start and finish line is 20 feet wide and marked by two upright markers (10 feet on each side of the center line) and short enough so as not to interfere with the timer if one is used. Short pylons are recommended. The first and second poles marking the center line are each 40 feet from the start and finish line, making them a total of 80 feet apart.
4. Failure of a contestant to cross the start and finish line between the markers will result in no time. Failure to cross over the center line between the markers before turning the second pole and crossing back over the center line after turning the second pole will result in no time.
5. Each pole or marker knocked over will add a 5-second penalty. If the original course is altered by a rider intentionally grasping a pole, a 5-second penalty for each pole grasped will be assessed. Failure to follow course is a disqualification. A contestant may touch a pole with his or her hand in the Stake Race.
6. The judge or designated officials may disqualify a contestant for cruelty or abuse to a horse and for excessive use of a bat, crop, whip, rope, or hands in front of the cinch.
7. No exhibitor may be tied, buckled, or fastened into the saddle in any manner or by any means during competition. (String, rubber bands, sandpaper, vet wrap, or other material designed to hold exhibitor's feet in the stirrups is prohibited.) See General Show Rules and Regulations number 32 for special needs situations.

Roping

General Rules and Regulations

1. A member can enter both individual roping events (Calf Roping or Breakaway). Each member may also enter Team Roping twice in one class (one time as a header and one time as a heeler and may ride the same or a different horse as a heeler).
2. A contestant will be allowed to have one person to help secure his or her horse in the box. Once this has been accomplished, the helper may stay in the box or in a designated area outside the box. The helper must leave the arena immediately following the run. Contestants are encouraged to supply their own pusher in the roping chute. If a contestant does not have a pusher, one will be supplied. Only show officials and exhibitors are permitted in the arena, and helpers **MUST** remain in the designated area (not considered part of the arena).
3. The flag judge may at his/her discretion award new cattle to enable contestants to show their horse's ability on the cow, including: 1) the cow won't run or stops; 2) chute or barrier malfunctions; 3) cow turns back immediately, or 4) cow leaves arena.
4. All calf and breakaway ropers must start from behind the barrier from the right side of the chute (heel box) with the steer (or calf) to the rider's left.



Legal bit



Illegal bit

Personal Appointments

Riders must wear boots and suitable clothing, including a shirt with a collar and long sleeves. Shirts must be tucked in and sleeves rolled down and fastened. Also, contestants are not to wear any type of head covering other than an equine safety helmet or an equine hard hat with fastened chinstrap. ASTM/SEI helmets are required (see rule 34 on page 15). Contestants violating these rules will receive no time.

Tack

Western-type equipment must be used. Use of a mechanical hackamore or other types of bridles is optional. No wire curbs, regardless of how they are taped, nor any chinstrap narrower than $\frac{1}{2}$ inch will be permitted. Chain curbs are permissible but must be of the flat variety with no twist. The use of approved chain mouthpieces is legal. Tie downs are permitted in roping classes. The mouthpiece must be at least $\frac{3}{16}$ inch in diameter. However, saw tooth or bicycle chain mouthpieces are illegal. No bare metal is allowed on any part of the horse's head, regardless of how taped or padded. Protective boots, leg wraps, and bandages are allowed. The judge may prohibit the use of bits, shoes other than standard horseshoes, or equipment that may be considered severe or inhumane (electrical devices are prohibited). No exhibitor may be tied, buckled, or fastened into the saddle in any manner or by any means during competition. (String, rubber bands, sandpaper, vet wrap, or other material designed to hold exhibitor's feet in the stirrups is prohibited.) See General Show Rules

and Regulations number 32 for special needs situations. The judges or designated officials may disqualify a contestant for cruelty or abuse to a horse and for excessive use of bats, crops, whips, ropes, or hands in front of the cinch.

Calf Roping

91 Calf Roping, Jr. 8–13

92 Calf Roping, Sr. 14–18

Western-type equipment must be used in Calf Roping. Types of bridles or other equipment used are optional choices of contestants. Jerk lines and "keepers" are acceptable; however, officials may prohibit use of any equipment they consider severe or inhumane.

Rules

A foul (neck) rope is mandatory. The rope must be run through a foul (neck) rope around the horse's neck and may, at the discretion of the rider, be run through a "keeper." If a keeper is used, it must be attached to the noseband of the tie-down and cannot be attached to the bit or bridle. If a horse drags a calf, judges may stop horse, and the roper may be disqualified.

1. All roping contestants will pay a \$15 cattle charge.
2. "Catch as catch can" roping is the name given conventional tie-down calf roping.
3. Two loops will be permitted. Should the roper desire to throw a second loop, he or she may recoil if carrying only one rope, or use second rope tied to the saddle. If the second loop falls loose, it cannot be rebuilt.
4. The roper may have one person to help secure his or her horse in the box, as described in the Roping General Rules and Regulations, and is encouraged to provide a pusher in the roping chute. If his or her horse drags a calf unnecessarily, a roper may be penalized by the flag judge.
5. The rope must be tied hard and fast in tie-down roping.
6. Contestants must rope calf, dismount, go down rope, throw calf by hand, and cross and tie any three feet.
7. To qualify as a legal tie, there must be one or more wraps and a half hitch.
8. If calf is down when roper reaches it, the calf must be let up to its feet and be thrown by hand.
9. If roper's hand is on the calf when calf falls, the calf is considered thrown by hand.
10. The rope must hold the calf until the roper gets his or her hand on the calf. The tie must hold and three legs remain crossed until passed on by judge.
11. The roper must not touch the calf after giving the finish signal until after the judge completes his or her examination. If tie comes loose or calf gets to its feet before the time has been ruled a fair one, the roper will be marked "no time."
12. Flag judges allow 6 seconds from the time the rope horse takes a step forward after the roper remounts to determine whether the tie is secure. The flag judge will have a stopwatch to determine the 6 seconds.
13. The rope should not be removed until the judge has passed on the tie.

14. Arena officials will usually include two or more timekeepers, a tie or field judge, and a deadline or score referee.
15. If the roper leaves the chute before the calf has passed the score line, he or she is given a 10-second penalty.
16. Mississippi 4-H will set score by flag and/or rope barrier (line about 8 feet in front of calf chute) or No. 2 RCA Rodeo Barrier.
17. Time scoring will begin when the head of the calf crosses the starting line and the flag judge signals. The roper has a maximum of 60 seconds to rope and tie the calf.
18. Any attempt to rope the animal before the barrier flag has been dropped will be a disqualification.
19. The scoring of the contest will be the time score plus any penalties.
20. Contestants must have a qualified time at the district show to be eligible for the state show.
21. Contestants will be given no more than two runs (only if needed) to get the final placings eligible to go on to other 4-H shows.
22. All calf ropers must start from behind the barrier from the right side of the chute (heel box) with the steer (or calf) to the rider's left.
8. Contestants must have a qualified time at the district show to be eligible for the state show.
9. Contestants will be given no more than two runs (only if needed) at the district show to get the final placings eligible for the state show.
10. At the state show, if the regional qualifying slot for breakaway roping is not filled after the first run, exhibitors will have the option for one rerun to fill the breakaway roping regional qualifying slot and must pay another cattle charge to compete.
11. All breakaway ropers must start from behind the barrier from the right side of the chute (heel box) with the steer (or calf) to the rider's left.
12. Show management shall provide string for breakaway roping.

Breakaway Roping

93 Breakaway Roping, Jr. 8–13

94 Breakaway Roping, Sr. 14–18

Other Rules for Breakaway Roping

1. Breakaway Roping is a timed event. The roper has a maximum of 60 seconds to complete the run.
2. A legal catch is a loop that passes over the head of the calf and then holds on any part of the calf to cause the string to break away from the saddle horn. Roping the calf without releasing the loop from the hand is not permitted.
3. Time will be called from the drop of the flag at the barrier to the break of the rope string from the saddle horn. A 10-second penalty will be added to the time for breaking the barrier. A regular rope is to be fastened to the horn or swell by a cotton string.
4. Two loops will be permitted. One or two ropes are to be tied to the saddle horn by a heavy string, in such a manner as to allow the rope to be released from the horn when the calf reaches the end of the rope. A visible cloth or flag must be attached to the end of the rope tied to the horn to make it easier for the flagger to see it break free.
5. If the roper is carrying one rope and the roper desires to use a second loop, he or she may recoil, provided the rope is still tied by a string to the saddle horn. If the rope is no longer attached to the saddle horn with the string after the roper has thrown the first loop, it cannot be rebuilt for a second throw. If the roper is carrying two loops, he may use the second loop, provided it is still attached to the saddle horn with a string. If the second loop falls loose, it cannot be rebuilt.
6. The contestant may free his or her first rope from the horn after a miss, before getting his second loop ready, if he or she wishes.
7. A contestant who uses any part of his or her body to break the rope from the saddle will receive a no time.
1. A team will consist of two current 4-H members. All contestants and horses must be eligible according to state 4-H horse show rules.
2. A 4-H member may enter Team Roping twice – only one time as a header and only one time as a heeler (can be different teams) and may ride the same or a different horse as a header or heeler. Team may be two boys, two girls, or one boy and one girl. Team members may be from different counties within any district.
3. This will be a timed event. Time starts with the release of the barrier and ends when the animal is roped, both horses facing animal in line with ropes dallied and tight; horse's front feet must be on ground.
4. The header will start behind the barrier from the left side of the chute (heading box) with the steer on the right and must throw the first loop at the head.
5. The heeler must start from behind the barrier line from the right side of the chute (heeling box) with the steer on the left.
6. Each contestant will be allowed to carry only one rope.
7. Team is limited to three throws. If more than one loop is to be thrown, rider must recoil rope and rebuild loop. Furthermore, the header must still head and the heeler must still heel. (No switching of headers and heelers allowed.)
8. Legal head catches are both horns, head and horn, or around the neck, so long as the rope passes over the horns. A front leg in the head catch is a disqualification. Heel catch must be on one or both hind legs. Heel catch must pass over the animal's hind feet first and not extend to the front shoulder to be considered a legal catch. Catching only one heel is a 5-second penalty.
9. It is an automatic disqualification when the header and heeler fail to complete both catches within 60 seconds from the time the animal leaves the chute.
10. The animal is not to be tied.
11. The ropes are not to be tied hard and fast.
12. Riders must remain mounted.
13. Animal must be standing up when roped by head or heels.
14. Loss of rope by either exhibitor is automatic disqualification.

Dally Team Roping

98 Dally Team Roping, exhibitors 8–18

Rules for Team Roping

15. The rope must be wrapped around the saddle horn at least one complete turn before it is considered a dally.
16. There will be a 10-second penalty assessed for breaking the barrier.
17. There will be a flagman (also serves as dally judge) and barrier judge.
18. Contestants will be disqualified for any abusive treatment of animals or their horses.
19. Roping animal without turning loose of the loop will be considered a "no catch."
20. If animal is roped by one horn, roper is not allowed to ride up and put rope over other horn or head with his or her hands.
21. If hondo passes over one horn, the loop over the other, the catch is illegal.
22. If loop crosses itself in head catch, it is illegal. This does not include heel catches.
23. If, in the opinion of the field flagger, a heel loop is thrown before the header has dallied and changed directions of an animal, the team will receive no time.
24. At the state show, team ropers who are legally entered and whose partners are not present or are unable to rope are allowed to team with another roper who is in the same circumstances. Individual ropers to decide on partner if more than one is available.

Goat Tying

100 Goat Tying, Jr. 8–13

101 Goat Tying, Sr. 14–18

Personal Appointments

Riders must wear boots and suitable clothing, including a shirt with a collar and long sleeves. Shirts must be tucked in and sleeves rolled down and fastened. Also, contestants are not to wear any type of head covering other than an equine safety helmet or an equine hard hat with fastened chinstrap. ASTM/SEI helmets are required (see rule 34 on page 15).

Contestants violating these rules will receive no time.

Tack

Western-type equipment must be used. Use of a mechanical hackamore or other types of bridles is optional. No wire curbs, regardless of how they are taped, nor any chinstrap narrower than ½ inch will be permitted. Chain curbs are permissible but must be of the flat variety with no twist. The use of approved chain mouthpieces is legal. The mouthpiece must be at least ¼ inch in diameter. However, saw tooth or bicycle chain mouthpieces are illegal. No bare metal is allowed on any part of the horse's head. Protective boots, leg wraps, and bandages are allowed. The judge may prohibit the use of bits, shoes other than standard horseshoes, or equipment that may be considered severe or inhumane (electrical devices are prohibited). No exhibitor may be tied, buckled, or fastened into the saddle in any manner or by any means during competition. (String, rubber bands, sandpaper, vet wrap, or other material designed to hold exhibitor's feet in the stirrups is prohibited.) See General Show Rules and Regulations number 32 for special needs situations. The judges or designated officials may disqualify a contestant for cruelty or abuse to a horse and for excessive use of bats, crops, whips, ropes, or hands in front of the cinch.

Time Limit

There will be a 45-second time limit.

General Rules

1. Starting lines in Goat Tying will be subject to ground rules.
2. A clearly visible starting line will be provided.
3. The stake and the starting line will be permanently marked for the entire go-round.
4. Arena permitting, the gate will be in the center between the two goats, allowing each contestant the same length to run at the goat.
5. Arena gate must be closed immediately after the contestant enters the arena and remain closed.
6. Time will be taken between two flags.
7. Time will start when the horse's nose crosses the starting line.
8. Collars must be the same and snug, ropes the same length, and goats the same size and weight.
9. Flagmen stand in identical places each performance.
10. Goats must be tied in this order: right, left, right, and left.
11. During goat tying, the arena will be dragged at regular intervals to be determined by the management.
12. Goat handlers must stand directly behind the goat. Judges and directors will position themselves so they are able to have a clear view of the goat rope and horse.
13. Once the exhibitor dismounts and is not in control of the horse, the horse may be caught for safety reasons during the goat tying.

Event Rules

1. The starting line should measure at least 15 yards.
2. The starting line will be 100 feet from the stake.
3. The goat should be tied to a stake with a 10-foot-long rope.
4. The stake should be completely under the ground so that no part of it is visible.
5. The contestant must be mounted on a horse and must ride from the starting line to the goat, dismount from the horse, and throw the goat by hand.
6. If the goat is down when the contestant reaches it, the goat must be placed on at least three feet (the goat must be elevated by the contestant so that at least three feet are dangling straight underneath the goat, or the goat must be rethrown). Then the contestant must cross and tie at least three legs together with a leather thong, pigging string, or rope, and stand clear of the goat.
7. Legs must remain crossed and secure for 6 seconds after completing the tie.
8. To qualify as a legal tie, there will be at least one complete wrap around at least three legs, and a half hitch, hooley, or knot.
9. Time will start when the horse's nose crosses the starting line.
10. Time will stop when the contestant signals the completion of the tie.
11. The contestant must move back 3 feet from the goat before the judge will start the 6-second time limit on the tie. The goat's legs must remain crossed and tied. If the rope that is holding the goat gets wrapped around the contestant's leg, the contestant may ask the judge for permission to remove it. After getting permission

from the judge, removing the rope, and moving back 3 feet, the contestant's 6-second time limit will start.

2. Qualified individuals other than goat-tying contestants will be used as goat holders.

Scoring and Penalties

1. The timed event judge will not flag contestants out until time is recorded.
2. The judge is to flag time, then flag contestant out if run is not legal.
3. A field judge will pass on the tie, and if it is not secure for 6 seconds, the contestant will receive no time.
4. The contestant will receive no time for touching the goat or tie string after signaling he or she is finished.
5. If the contestant's horse crosses over the rope or goat, or if the contestant's horse comes in contact with the goat or rope at any time, a 10-second penalty will be assessed to the contestant between flags.
6. If the horse causes the goat to break away, the contestant will receive no time between flags.

Reruns

1. No run will be given due to faulty or broken equipment furnished by a contestant in any event.
2. If the goat should break away, it will be left to the judge's discretion whether or not the contestant will get a rerun.
3. If a digital clock malfunctions and if stock was qualified on in the field, the contestant will be given a rerun at a time designated by the judges and the management, plus any penalties.
4. If the judge sees he or she made an error in flagging, he or she must declare a rerun before the contestant leaves the arena.

Ranch Horse Division

Personal Appointments

Clothing should be clean and neat. Shirts with a collar and long sleeves are required, along with western boots.

Tack

See Western Division rules on page 23.

Ranch Riding

102 Ranch Riding, Jr. 8-13

103 Ranch Riding, Sr. 14-18

Ranch Riding serves to measure the ability of the horse to be functional and a pleasure to ride at a working speed while being used as a means of conveyance from one western stock horse task to another. This horse should be well-broke, relaxed, quiet, soft, and cadenced at all gaits. The horse should be responsive to the rider, yield to contact, and make all required transitions smoothly, timely, and correctly. The horse should perform with reasonable speed, and be obedient, well-mannered, free, and easy moving.

This class will be held at the state show with no district eliminations (optional at district shows). Entries must be sent to Animal and Dairy Science Department, Attn: Dean Jousan, Box 9815, Mississippi State, MS 39762, by May 1 of the current year.

****Rule:** A horse/rider combination may participate in only one pleasure class (either Pony Pleasure/Western Pleasure or Ranch Riding).

1. Classes consist of pattern work, which is ridden individually. For each maneuver, the horse is judged on quality of gaits, response to the rider, manners, and disposition.
2. A horse will be given credit for traveling with his head held in a normal position, ears alert, and moving at a natural speed for the gait requested. The horse should be ridden on a relatively loose rein with light contact and without requiring undue restraint. Excessively long floppy reins will not be given extra credit.

Ranch Riding Pattern 1

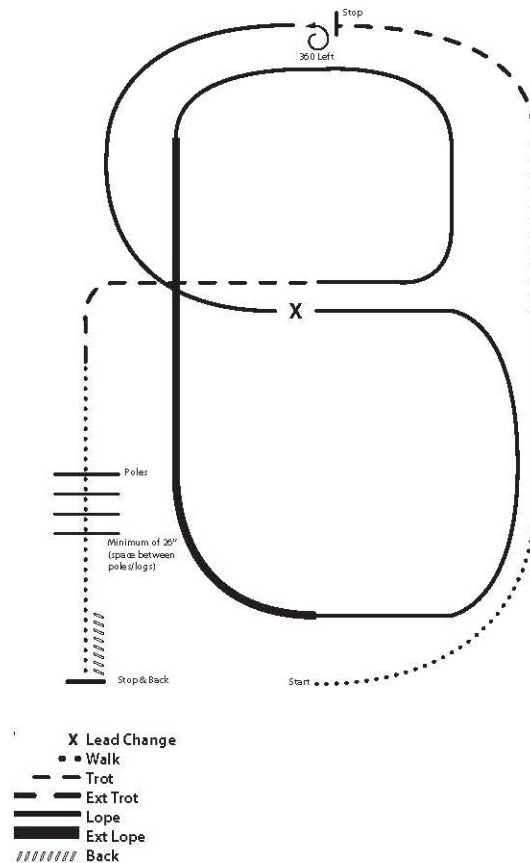

1. Walk
2. Trot
3. Extend the trot, at the top of the arena, stop
4. 360 degree turn to the left
5. Left lead ½ circle, lope to the center
6. Change leads (simple or flying)
7. Right lead ½ circle
8. Extended lope up the long side of the arena (right lead)
9. Collect back to a lope around the top of the arena and back to center
10. Break down to an extended trot
11. Walk over poles
12. Stop and back

3. Tack and Equipment: Ranch work equipment and attire is recommended, but show equipment and attire will not be penalized. See equipment rules under general Western Division tack.
4. Use of hands: Only one hand may be used on reins, and hands must not be changed. Reins may be held in any manner. Two

hands may be used when using a snaffle bit or bosal on a horse or pony 5 years of age or younger.

5. There will be one pattern, which will be used for all shows. The class may be conducted inside or outside of an arena. Markers shall be setup to designate where gait changes should occur.
6. To break ties or to resolve close placings, the judge, at his/her discretion, may require designated contestants to work on the rail or repeat any portion of the pattern.

Ranch Riding Pattern 2

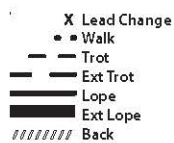
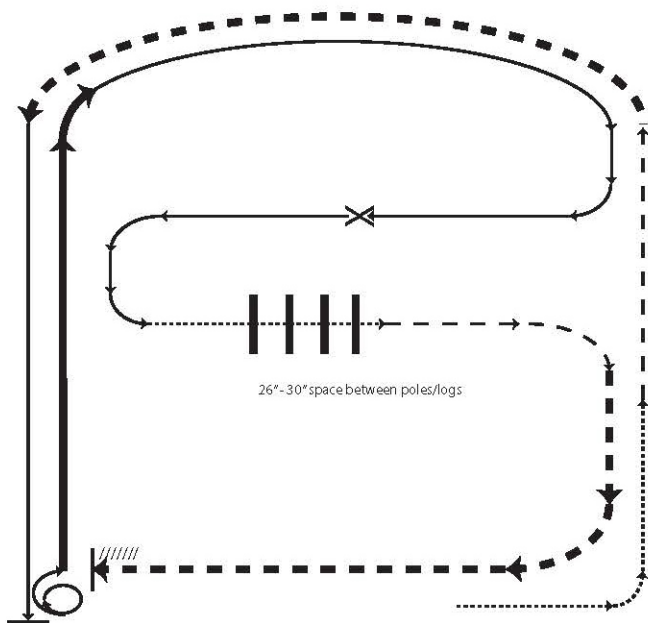

1. Walk
2. Trot
3. Extended trot
4. Left lead lope
5. Stop, 1½ turn right
6. Extended lope
7. Collect to working lope, right lead
8. Change leads (simple or flying)
9. Walk
10. Walk over logs
11. Trot
12. Extended trot
13. Stop and back

Ranch Riding Pattern 3

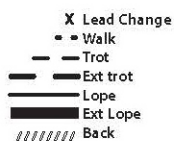
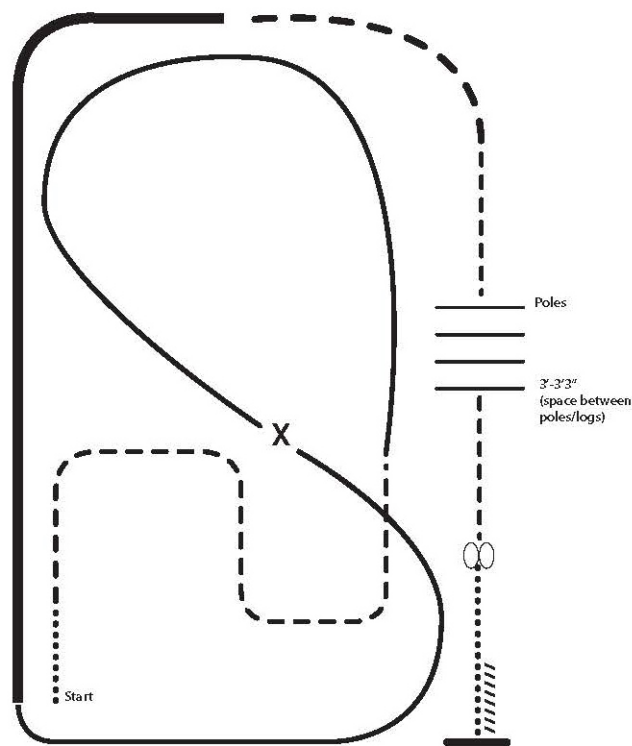

1. Walk
2. Trot serpentine
3. Lope left lead around the end of the arena and then diagonally across the arena
4. Change leads (simple or flying)
5. Lope on the right lead around end of the arena
6. Extend lope on the straight away and around corner to the center of the arena
7. Extend trot around corner of the arena
8. Collect to a trot
9. Trot over poles
10. Stop, do 360 degree turn each direction (either direction first)
11. Walk, stop, and back

7. Part of the evaluation of this class is on smoothness of transitions. All transitions should be smooth without undue exaggeration or resistance from the horse.
8. Description of Ideal Gaits – The ideal ranch riding horse will have a natural head carriage at each gait – neither too high nor too low.
 - a. Walk – The walk should be straight, square, flat footed, relaxed, with the horse moving out freely and looking ahead.
 - b. Trot – This gait should be a square two-beat diagonal trot. The trot should be steady, soft, and slow enough for riding long distances. Trots that are rough and hard to sit should be penalized. Excessively slow and uncadenced trots should also be penalized.

- c. Extended Trot – The extended trot should show an evident lengthening of stride from the regular trot with the same cadence that will cause an increase in speed. This trot should be level, flat, and steady with the appearance that the horse could hold this gait for an extended distance.
- d. Natural Gait and Extended Natural Gait – Non-trotting horses should perform their natural gait where a trot is indicated and show a distinctive difference in speed of that gait where an extended trot is asked. The natural gait should be smooth and appear effortless for riding long distances.
- e. Lope – This gait should be a three beat gait that is cadenced, straight, and steady, and comfortable to ride over long distances. Excessively slow or 4 beat lope should be penalized.
- f. Extended Lope – The extended lope should be an obvious lengthening of stride from the previous lope, be at the same cadence, and cause an increase in speed. The gait needs to be steady, quiet, and maintain the increased speed while being under control.
- g. Stop (from both lope and trot) – The horse should be in the correct stopping position – both hocks engaged and stopping on the hindquarters.
- h. Reverse – A horse should turn briskly and flat with front feet, while holding an inside rear pivot foot.
- i. The extended trot may be ridden with the rider either posting or standing in the stirrups to the front of the saddle. Holding the saddle horn is permissible, at this gait, as might be done in open terrain. When transitioning from the extended trot to the lope, it is permissible to take the horse back a bit (collecting) before loping.

Ranch Riding Pattern 4

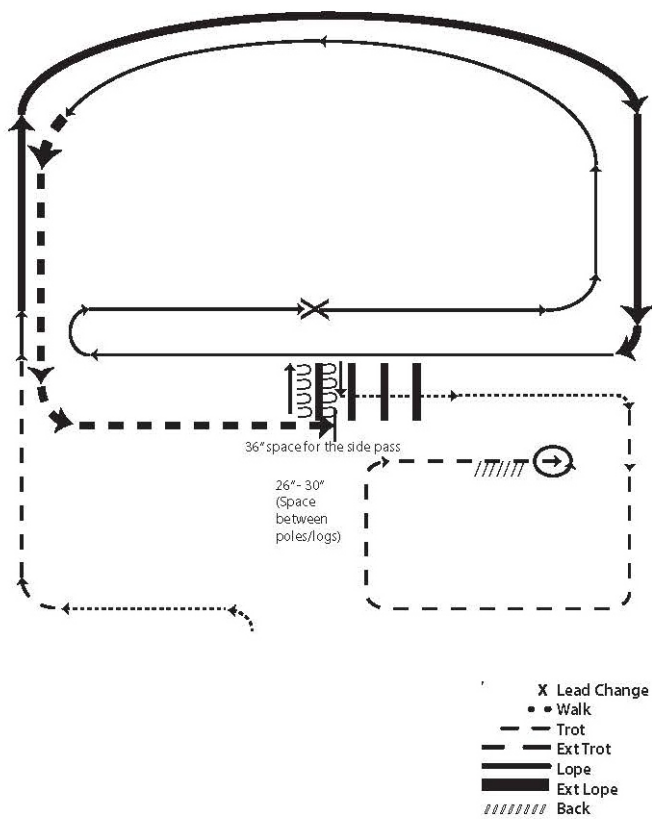

1. Walk
2. Trot
3. Extend lope, right lead
4. Lope, right lead
5. Change leads (simple or flying)
6. Lope left lead
7. Extended trot
8. Stop, side pass left, side pass right, 1/2 way
9. Walk over logs
10. Walk
11. Trot square
12. Stop, 360 degree turn left, back

9. Each horse will work individually, performing the required gait maneuvers and a minimum of three optional maneuvers. Horses will be scored on the basis of 0 to 100, with 70 denoting an average performance. Each maneuver will receive a score that should be added or subtracted from 70 and is subject to a penalty that should be subtracted. Each maneuver will be scored on the following basis, ranging from +1½ to -1½: -1½ extremely poor, -1 very poor, -½ poor, 0 correct, +½ good, +1 very good, +1½ excellent. Maneuver scores are to be determined and assessed independently of penalty points. Natural ranch horse appearance will also be evaluated ranging from +1½ to -1½.

Ranch Riding Penalties. A contestant shall be penalized each time the following occur:

One point

- Too slow (per gait)
- Over-bridled (per maneuver)
- Out of frame (per maneuver)
- Break of gait at walk or trot for 2 strides or less
- Wrong lead or out of lead for 2 strides or less

Three points

- Break of gait at walk or trot for more than 2 strides
- Break of gait at lope, except when correcting an incorrect lead
- Wrong lead or out of lead for more than 2 strides
- Draped reins (per maneuver)

- Out of lead or cross-cantering more than two strides when changing leads
- Trotting more than three strides when making a simple lead change
- Severe disturbance of any obstacle
- Trotting for more than 3 strides in lope departures or when exiting a rollback

Five points

- Blatant disobedience (kick, bite, buck, rear, etc.) for each refusal

Ten points

- Unnatural ranch horse appearance (Horse's tail is obvious and consistently carried in an unnatural manner in every maneuver)

Disqualification (should not be placed)

- Eliminates or adds maneuver
- Incomplete maneuver
- Use of two hands (except junior horses shown in a snaffle bit/hackamore), more than one finger between split reins or any fingers between romal reins
- Repeated blatant disobedience
- Illegal equipment including hoof black, braided or banded manes, or tail extensions
- Willful abuse
- Major disobedience or schooling
- Lameness

Ranch Trail

104 Ranch Trail, Jr. 8–13

105 Ranch Trail, Sr. 14–18

These classes are designed to show the horse's ability to navigate and cope with the various situations and obstacles encountered in everyday ranch work. It is designed to show a horse's ability to perform these obstacles with a willing attitude. The horse is judged on cleanness and promptness with which the obstacles are negotiated, ability to negotiate obstacles correctly, and attitude and mannerisms exhibited by the horse while negotiating the course.

This class will be held at the state show with no district eliminations (optional at district shows). Entries must be sent to Animal and Dairy Science Department, Attn: Dean Jousan, Box 9815, Mississippi State, MS 39762, by May 1 of the current year.

****Rule:** A horse/rider combination may participate in only one trail class (either Western Trail or Ranch Trail).

Whenever possible, realistic or natural obstacles should be used. The course can be laid outside of the arena using natural terrain. However, if a ground tie is specified in the course, the course must be set up in an enclosed arena.

1. The judge must walk the course and has the right and duty to alter the course in any manner. The judge may remove or change any obstacle he/she deems unsafe or non-negotiable before the start of the class. If at any time a trail obstacle is deemed to be unsafe by the judge, it shall be repaired or removed from the course. If it cannot be repaired and horses have completed the course, the score for that obstacle shall be deducted from all previous works for that class.

2. At least two or three obstacles will be designated as tie breakers and shall be selected before the beginning of the competition. One of the mandatory obstacles should be used as the first tie breaker.

3. Tack and Equipment:

- a. Ranch work equipment and attire is recommended, but show equipment and attire will not be penalized.
- b. Wearing gloves, leather or fabric, is optional. Roping gloves may be worn for the duration of the class or may be worn only for the roping and log drag obstacles.
- c. Roping reins are not allowed. See equipment rules under general Western Division Tack.

4. The horse will be shown at a ground-covering walk, trot (or natural gait), and lope between the obstacles, and credit will be given for performing these gaits on the correct lead with an alert attitude. The walk may be judged as part of an obstacle. Between obstacles, at least 30 feet should be allowed for the trot, and at least 50 feet for the lope. Gaits between obstacles will be scored as part of the next obstacle.

5. Extending the trot or natural gait may also be asked. The extended trot may be ridden with the rider either posting or standing in the stirrups to the front of the saddle. Holding the saddle horn is permissible, at this gait, as might be done in open terrain.

6. No additional credit will be given for unnecessary/additional maneuvers (such as sidepassing to and from an obstacle).

7. The judge may ask a rider to move on to the next obstacle if the horse/rider is unable to complete the maneuver in a reasonable time or if the judge deems that the rider is, or will be, in an unsafe situation. The judge may also ask the rider to move on after a third refusal at an obstacle.

- a. A rider will lose 15 points if an obstacle is attempted and not completed.

- b. The maximum points a rider can lose on any one attempted obstacle is 15 points.

8. A rider may elect to skip an obstacle without disqualification. He/she may do so with the judge assigning a 20 point penalty.

9. Scoring will be on the basis of 0-infinity, with 70 denoting an average performance. Each obstacle will receive an obstacle score that should be added or subtracted from 70 and is subject to a penalty that should be subtracted. Each obstacle will be scored on the following basis, ranging from +1½ to -1½:

-1½ extremely poor

-1 very poor

-½ needs improvement

0 correct

+½ good

+1 very good

+1½ excellent

Obstacle scores are to be determined and assessed independently of penalty points. Penalties should be assessed per occurrence as follows:

One-half point

- Each tick of log, pole, cone, plant, or any component of the obstacle.

One point

- Each bite of or hit of or stepping on a log, cone, plant, or any component of the obstacle.
- Incorrect or break of gait at walk or jog for two strides or less.
- Both front or hind feet in a single-strided slot or space at a walk or jog.
- Skipping over or failing to step into required space.
- Split pole in lope over.
- Incorrect number of strides, if specified.
- Each step, up to three steps, moved during ground tie or picking up hooves.

Three points

- Incorrect or break of gait at walk or jog for more than 2 strides.
- Out of lead or break of gait at lope (except when correcting an incorrect lead).
- Knocking down an elevated pole, cone, barrel, plant, obstacle, or severely disturbing an obstacle.
- Falling or jumping off of a bridge with one foot once the horse has gotten onto that obstacle.
- Stepping outside the confines of, falling, or jumping off or out of obstacle, with designated boundaries, with one foot.
- Missing or evading a pole that is a part of a series of an obstacle with one foot.

Five points

- Dropping slicker, log rope, or object required to be carried on course.
- Dropping lariat anywhere on course other than after completion of roping obstacle.
- First or second cumulative refusal, balk, or evading an obstacle by shying or backing.
- Letting go of gate or dropping rope gate.
- Use of either hand to instill fear or praise.
- Stepping outside the confines of an obstacle with designated boundaries (i.e., back through, 360 degree box, side pass) with more than one foot once the horse has entered the obstacle.
- Blatant disobedience (including kicking out, bucking, rearing, striking).
- Missing or evading a pole that is a part of a series of an obstacle with more than one foot.
- Moving more than 3 steps during ground tie or picking up hooves. (Note: "Holding the saddle with either hand" is a 5-point penalty in Western Trail but is not a penalty in Ranch Trail.)

Faults, which occur on the line of travel between obstacles, are scored according to severity:

- Head carried too high
- Head carried too low and/or clearly behind the vertical excessively and consistently while the horse is in motion, or otherwise showing the appearance of intimidation.
- Opening mouth excessively

Disqualified (should not be placed)

- Use of two hands (except for junior horses shown with hackamore or snaffle bit) or changing hands on reins. But it is permissible to change hands to work an obstacle as outlined in Western Equipment or to straighten reins when stopped.
- Use of romal other than as allowed in Western Equipment.
- Performing the obstacle incorrectly or other than in specified order.
- No attempt to perform an obstacle.
- Equipment failure that delays completion of pattern.
- Excessively or repeatedly touching the horse on the neck to lower the head.
- Entering or exiting an obstacle from the incorrect side or direction.
- Working obstacle the incorrect direction, including overturns of more than 1/4 turn.
- Riding outside designated boundary marker of the arena or course area.
- Third cumulative refusal, balk, or evading an obstacle by shying or backing.
- Failure to ever demonstrate correct gait between obstacles as designated.
- Failure to follow the correct line of travel between obstacles.
- Excessive schooling, pulling, turning, stepping, or backing anywhere on course.
- Failure to open and shut gate or failure to complete gate.

10. Six to ten obstacles will be used. Three will be mandatory, and the remaining will be selected from the optional list.

a. Mandatory Obstacles:

- Opening, passing through, and closing a gate.
- Log drag – Horse must be willing to drag a log for a short distance in a straight line. Rider to pick up rope while mounted at point A, and drop rope at point B. Rope may not be tied hard and fast to the saddle horn; dallying is optional. Log size should be roughly the size of a small fence post, suggested maximum weight approximately 30 pounds. Rope should be securely attached to one end of the post by either drilling a hole through the post and tying a bowline (or other non-slip knot), or attaching an O-ring and tying a non-slip knot through the ring.
- Stationary steer – This obstacle is used to show the willingness of the horse to have a rope thrown from its back. The judge will give credit to the horse that stands quietly while the contestant makes the swing and throw at the stationary steer. Shying from the rope will be penalized, but missing the stationary steer will not be penalized. Rider must provide the rope for this obstacle; rope may be carried in hand, over saddle horn, or affixed to saddle. At the completion of this obstacle, contestant may coil rope and keep for remainder of class, or drop rope at obstacle without penalty.

b. Optional Obstacles:

- Mailbox – Rider will open and close a mailbox when mounted.
- Bridge – Horse should walk willingly over a stationary bridge.

- Slicker – The rider shall show the ability to handle the horse while simulating putting on a slicker. The rider may also be asked to carry the slicker from point A to point B.
 - Walk-over log-L obstacle – Walk over 90° log “L”. Log should be no less than 6” and no more than 12” in diameter. Riders should negotiate this obstacle in a straight line.
 - Step-overs at a walk, trot, or lope – Natural branches, logs, fence posts, etc., which are laid out in seemingly random angles and distances. Distances should be measured only so the set-up is repeatable, but not for uniform spacing or stride length. Obstacles may not be raised and the maximum height of any step-over is 8”.
 - Water hazard – The horse should enter and exit the water hazard in a quiet manner.
 - Back through obstacle – Straight, “L”, or into/out of a marked location.
 - Sidepass – Straight, one direction, may or may not be elevated.
 - Ground tie – Rider must be able to dismount and walk a minimum of 5 paces away with the horse in a designated spot. If used, no remount will be required and class must be held in an enclosed arena. If a rider is using a one-piece rein (romal, roping rein, etc.), it should be unsnapped from the bit on one side while ground-tying.
 - Pick up front feet – The rider must be able to dismount and pick up both front feet in an easy, time efficient manner. If used, this must be the last obstacle of the course (no remount). May be used in succession with ground tie so rider only dismounts once per course.
 - Any other safe and negotiable obstacle that could reasonably be found in everyday ranch work and meets the approval of the judge.
- c. If disrupted, the course shall be reset. In the case that an obstacle is used in combination, the obstacle cannot be reset until the contestant finishes the entire combination.

Ranch Roping

108 Ranch Roping, exhibitor 8–18

Tack and Equipment: See general Western Division tack.

The goal of this class is to show the ability of the horse and the rider’s skill in handling cattle as if they were doctoring injured or sick cattle. Cattle should be handled as calmly and slowly as possible. The judge should judge this class as if the cattle belonged to him or her. Exhibitor does not have to separate the cow from herd and should not receive credit for separation from herd. If the cow is separated from the herd, there should be no running or cutting of the cow. This is a judged event with a 2-minute time limit. A 30-second warning will be given before the end of the run. The rope must be thrown, and the contestant may rebuild and throw an unlimited number of loops. No credit will be given for additional loops after a successful catch of any part of the animal. The honda on the rope used must be of a breakaway design. Ropes may not be tied hard and fast to the saddle horn.

For this event, the arena will be shortened with the addition of portable panels. The exhibition area should typically be the normal width of the arena (usually 100–150 feet) by 45–75 feet. Show management or the

judge may make adjustments to the size of the arena to allow for the temperament of the cattle.

Horse and rider must start from an entrance gate, which will be opposite from where 10 calves/yearlings are held as a herd with each bearing a number 0–9. A random draw will be used to select the calf to be roped, which will be announced to the contestant when the horse enters the arena gate.

The contestant should make a desired catch, position their horse in an appropriate manner, and dally up. A desired catch is defined as one in which the animal is roped, and the rope comes tight in front of the animal’s shoulders. A catch of any other part of the animal will be considered legal, but the exhibitor will receive a penalty. When the calf breaks free from the honda, the Flag Judge will signal the end of the run. In order to receive a score, the exhibitor must have a dally (full wrap) in place at the time the animal breaks free from the honda.

The show committee will provide one to two herd-holders. The sole duty of the herd-holders is to settle the cattle before the event and between runs.

Scoring will be on the basis of 0 to 100, with 70 denoting an average performance. Each maneuver will be scored from plus three to minus three in half-point increments. Credit will be given for: ability to sort, stopping, ability to rope out of the herd without disturbing other cattle, dallying, ability to manage coils, ability to manage rope and position of horse while dallying, difficulty of a throw that results in a successful catch.

Penalties

Ten points

- Roping any portion of the cow other than the head/neck.

Five points

- Multiple loop run (penalty may be assessed for each rebuild with a maximum of 15 points taken).
- Running/scattering of the herd.
- Blatant disobedience of the horse including kicking, biting, rearing, or striking.
- Inability of rider to efficiently recoil and build a loop after a miss.

Three points

- Too much time in the herd without roping.
- Loss of cow (re-cut in the herd).

One point

- Loss of working advantage.

Disqualification (should not be placed)

- Running into or over cattle.
- Schooling.
- Whipping or hitting horse with rope.
- Thrown from horse.
- Fall to ground.
- Loss of rope.
- Roping wrong cow.
- Roping more than one cow with the same loop.
- Excessive running of the cattle.
- Failure to catch.

Ranch Pleasure

109 Ranch Pleasure, Jr. 8–13

110 Ranch Pleasure, Sr. 14–18

Tack and Equipment: See general Western Division tack.

This class will be held at the state show with no district eliminations (optional at district shows). Entries must be sent to Animal and Dairy Science Department, Attn: Dean Jousan, Box 9815, Mississippi State, MS 39762, by May 1 of the current year.

Entries may not cross-enter in Western Pleasure class but may enter Ranch Riding (i.e., same contestant could enter both Ranch Riding and Ranch Pleasure but not Western Pleasure and Ranch Riding or Ranch Pleasure).

The Ranch Pleasure class measures the ability of the horse to be a pleasure to ride while being used as a means of conveyance from one ranch task to another and should reflect the versatility, attitude, and movement of a working horse. The horse should be well-broke, relaxed, quiet, soft, and cadenced at all gaits. The horse should be ridden on a relatively loose rein with light contact and without requiring undue restraint. The horse should be responsive to the rider and make timely transitions in a smooth and correct manner. The horse should be soft in the bridle and yield to contact. The ideal ranch pleasure horse should have a natural head carriage at each gait. In all gaits, movement of the ranch pleasure horse should simulate a horse needing to cover long distances, softly and quietly, like that of a working ranch horse. This class should show the horse's ability to work at a forward, working speed while under control by the rider. Light contact should be rewarded, and the horse shall not be shown on a full drape of reins. The overall manners and responsiveness of the horse's quality of movement are the primary considerations. Part of the evaluation of this class is on smoothness of transitions. A horse may be collected from the extended trot as the horse moves into the lope.

Class format: All horses will be worked together, both ways of the arena at walk, trot, and lope. Exhibitors may be asked to extend any gait. Posting at the extended trot is acceptable. All horses will be asked to back. When splits or heats are used, the back-up may or may not be asked but all finalists must be asked to back. When splits or heats are used, judge will use same gait calls (order may differ) for each split/heat. Reversal of the ring may be at the walk or trot but not at the lope.

Ranch Pleasure faults:

- Too slow per gait
- Over-bridled or out of frame
- Break of gait
- Out of lead or wrong lead
- Draped reins
- Blatant disobedience
- Use of either hand to instill fear or praise

Disqualifications (should not be placed):

- Use of two hands (except junior horses shown in a snaffle bit or hackamore), more than one finger between split reins, or any fingers between romal reins
- Repeated blatant disobedience
- Illegal equipment including hoof black, braided or banded manes, or tail extensions
- Willful abuse

- Major disobedience or schooling
- Lameness

Ranch Sorting

99 Ranch Sorting, exhibitors 8–18

Ranch sorting is derived from the ranching practice of sorting cows from calves or steers from heifers where finesse, agility, and cattle working skills excel. It is a fun competitive timed event that matches a two-rider team against 11 head of cattle to be sorted in numerical order from one sorting pen to another. The most cattle sorted in the fastest time wins.

Personal Appointments

Riders must wear boots and suitable clothing, including a shirt with a collar and long sleeves. Shirts must be tucked in and sleeves rolled down and fastened. Also, contestants are not to wear any type of head covering other than an equine safety helmet or an equine hard hat with fastened chinstrap. ASTM/SEI helmets are required (see rule 34 on page 15). Contestants violating these rules will receive no time.

Tack

Western-type equipment must be used. Use of a mechanical hackamore or other types of bridles is optional. No wire curbs, regardless of how they are taped, nor any chinstrap narrower than ½ an inch will be permitted. Chain curbs are permissible but must be of the flat variety with no twist. The use of approved chain mouthpieces is legal. Tie downs and running martingales are permitted in Ranch Sorting. The mouthpiece must be at least ⅜ inch in diameter. However, saw tooth or bicycle chain mouthpieces are illegal. No bare metal is allowed on any part of the horse's head. Protective boots, leg wraps, and bandages are allowed. The judge may prohibit the use of bits, shoes other than standard horseshoes, or equipment that may be considered severe or inhumane (electrical devices are prohibited). No exhibitor may be tied, buckled, or fastened into the saddle in any manner or by any means during competition. (String, rubber bands, sandpaper, vet wrap, or other material designed to hold exhibitor's feet in the stirrups is prohibited.) See General Show Rules and Regulations number 32 for special needs situations. The judges or designated officials may disqualify a contestant for cruelty or abuse to a horse and for excessive use of bats, crops, whips, ropes, or hands in front of the cinch.

1. Ranch Sorting is open to 4-H members 8–18 years of age. All contestants and horses must be eligible according to the current year's Mississippi 4-H Horse Show Classes, Rules, and Regulations.
2. This class will be held at the state show with no district eliminations (optional at district shows). Entries must be sent to Animal and Dairy Science Department, Attn: Dean Jousan, Box 9815, Mississippi State, MS 39762, by May 1 of the current year.
3. A team will consist of two riders 8–18 years of age. Contestants can enter this class only one time. Team members may be from different show districts.
4. The basic concept of ranch sorting is that there are 10 numbered cattle, 0-9, and one unnumbered cow for a total 11 head at the beginning of a run behind a foul line in an arena with two people mounted on the other side of the foul line.
5. Ranch sorting will take place between two pens of approximately equal size with show management's option of working cattle back and forth or only one way. Two ranch sorting arenas may be placed side by side with odd numbered teams in one arena

and even numbered teams in the other arena. If cattle are to be worked back and forth, they need to be moved to the opposite pen and back before each new herd entering the arena is worked. Recommended sorting area to be 50' to 60' in diameter with no 90 degree corners (e.g., 60' round pen or octagonal "stop sign" design).

6. The start foul line will be recommended as a 12' to 16' opening between the two pens.
7. There will be a 90 second clock for this class. The official time of each run is determined by the amount of time used until all 10 cattle are sorted or the time limit has expired. Time will continue until all cattle are sorted in the correct order or the time limit is reached, either of which becomes the official time for that team.
8. A lap timer is to be used in all sorting classes to break ties where the cattle count is equal in runs of less than 10 cattle sorted. The stopwatch used for lap time purposes will also be the back-up timer in the event of a malfunction of the official clock.
9. There will be one judge for sorting to be positioned evenly with the foul line.
10. All cattle will be bunched on the cattle side of the gate within the designated area before the time begins. At the conclusion of each run, the judge will designate the need to bunch cattle.
11. The judge will raise the flag to signal when the arena is ready. The flag will drop when the nose of the first horse crosses the start/foul line and the announcer will provide the number to be sorted first. The riders will be given their number instantly. Any delay in crossing the foul line may result in a "no-time" for the team. With particular interest, that no one or two cattle are isolated.
12. All cattle must have approved back numbers; neck numbers are not acceptable. The cattle are sorted in order. If any part of a numbered cow crosses the start/foul line before its correct order, then the team receives a no-time. If any part of a sorted cow re-crosses the start/foul line, the team will be disqualified. If any part of any unnumbered cow crosses the foul line before the 10th cow is cleanly sorted, it will result in a no-time.
13. To determine the order of sorting, the announcer/timer will pick a random number; the cow with that number must be sorted first. For instance, if 5 is drawn as the first number, 5 is sorted first, then cows 6, 7, 8, 9, 0, 1, and so on. A cow is considered sorted when the entire cow is completely across the start/foul line. If two or more cows cross the line together, as long as the nose of the correct number or numbers cross the line first, the cattle are considered to be in order regardless of whether they finish crossing in that order.
14. If there is a malfunction of the sorting pen or a numbered cow jumps any fence and either leaves the arena or ends up in the opposite pen, but did not pass through the gate (assuming it was not caused by roughing of the cattle), at judge's discretion, a re-ride or a no-time can be given. All re-rides will occur immediately using the same numbered cattle starting at zero cattle with a new clock. Time can also be given on sorted cattle at the time a numbered cow leaves the arena.
15. Should a herd be numbered incorrectly or have too many non-numbered cattle, a rerun must be given immediately, using the correct number within that same herd. If a duplicate number is called within the same set of cattle, a re-ride will be given immediately upon point of discovery using the same set of cattle

with any number that has not already been used. Those re-rides will begin at zero time and zero cows. Re-rides may also be given for official or mechanical errors or downed cattle. In these cases, contestants will be given the option to take their time on the number of cattle sorted when the run is stopped by the official or re-ride immediately with the same numbered cow beginning at a time of zero.

16. Prior to a team crossing the start/foul line, the team must notify the judge of any unnumbered, injured, or unfit cattle. Once brought to the judge's attention, the judge (not the contestants) will determine whether to correct the problem or proceed forward. No re-rides will be given once a team has committed to the cattle by crossing the start/foul line. If, at the judge's discretion, a re-ride is given because of unnumbered, injured, or unfit cattle, the re-ride will occur immediately using the same numbered cattle once unnumbered, injured, or unfit cattle are replaced.
17. Any unnecessary roughness to cattle or horses or unsportsmanlike conduct may result in disqualification.
18. Any excessive use of a whip, rope, crop, bat, or reins anywhere on the horse will be cause for disqualification.
19. Ranch sorters are allowed to substitute one rider on the team when one member is unable to participate in the state show. However, a substitute rider must have participated in the district 4-H horse show and/or be entered in the state show. Any substitution must be made at least 15 minutes before the start of class.

Awards for State Show

Riffey Parker Memorial Award—presented to the individual who wins first place in Western Pleasure Junior 12–13.

Swazy Woodruff Memorial All-Around Award—presented to the individual (junior or senior) who competes in nonriding contests at district or state competition and accumulates the highest number of points in the state 4-H horse show. (See full details in later section.)

County Educational Display Award—presented to the county that has the most outstanding educational display. (See full details in later section.)

Roland (Pee Wee) Stacy Memorial Awards—presented to the overall-high individual (junior and senior) member.

Dr. Edward North Memorial Awards—presented to the horses (one owned by a junior and one by a senior member) that score the most points. (Points scored on a one rider, one horse basis.)

H.B. Hedgepeth Memorial Award—presented to the county that accumulates the most points.

High-Point Awards for Division Winners—champion high-point horse (junior or senior) will be awarded in the following divisions:

- Saddle and Gaited division (sponsored by the parents of Saddle and Gaited exhibitors for the 4-H Winter Classic Show Series)
- Western division (sponsored by Tom McBeath Quarter Horses)
- Speed division
- Hunter division (sponsored by David Misenhalter, North Grove Equestrian Park)
- Cattle and Goat Events division
- Ranch division (sponsored by S&S Trailers)

Breakdown of classes for high-point awards will be as follows:

Western Classes: 1-14, 21-24, 40-44, 46-47, 51-52, 54

Saddle and Gaited Classes: 15-16, 25-36

Hunter Classes: 57-60, 62-63, 67-69, 71-72

Pony Classes: 17-20, 37, 56

Speed Events Classes: 75-78, 81-84, 87-90

Pony Speed Events Classes: 73-74, 79-80, 85-86

Cattle and Goat Division Classes: 91-94, 98, 100-101

Ranch Classes: 95-96, 99, 102-110

NOTE: All Walk/Jog, Walk/Trot, Cross Rails, Introductory, and Special Needs classes do not count toward high point awards. These include classes 38-39, 45, 50, 53, 55, 61, 66, 70, and 97. Classes 48-49 and 64-65 will count toward a horse's and youth's high point totals.

In the case of a tie, high-point awards will be determined by counting the total number of horses beaten in all classes. If a tie still exists, most points earned in the greatest number of classes will be used to determine high-point awards. Remaining ties will be broken by determining the most points earned in performance classes. If there are still ties after these methods, the remaining tied horses will be declared co-champions.

Award points in all classes based on the following: The maximum number of horses placed in each class will be 12. Points will be awarded based on the number of horses placed. For example: In a Western Pleasure class, assume there are 32 horses shown. Twelve horses will be placed (1st through 12th); the 1st-place horse will receive 12 points, and the 12th-place horse will receive 1 point. If three horses are in a performance class, three horses are placed, and the top horse receives three points. The same procedure applies to halter classes. The number of horses in a class will be determined by the number actually shown. Horses brought into the ring will constitute an entry and will be counted; however, a disqualified contestant will not receive points.

Halter and Performance Classes

The champion and reserve champion halter horses will receive two points and one point, respectively, more than any other horse in that breed and sex. For example: If the champion quarter horse gelding comes from a class that has three other horses, he will receive two more points than any other halter winner in the quarter horse geldings. So, in a class with 12 quarter horse geldings, the champion gelding will receive 14 points. The reserve champion will receive one point more as outlined. Trophies will be presented for the first three places in each class. The grand champion will receive a trophy, and the reserve grand champion will be presented a rosette.

Qualifying Horses for Regional Show

Mississippi can qualify 70 horses for the regional 4-H horse show. Extension 4-H youth agents have the qualifying system and rules and classes that are eligible. Exhibitors with horses qualifying on Wednesday, Thursday, Friday, and Saturday must pay the regional entry fee within 30 minutes of the last qualifying class each day or forfeit the right to go to the regional show. At the conclusion of the show each night, a list of high-point horses will be made that will include juniors and seniors for all regional qualifying classes held that particular day. This list will be used to fill any vacancies for the Southern Regional 4-H Horse Show that were not filled from the show that particular day. At the conclusion of the show on Saturday night, a list of high-point horses that includes

juniors and seniors for all regional qualifying classes during the State 4-H Horse Championships will be made. This list will be used to fill any vacancies for the Southern Regional 4-H Horse Show that were not filled from the shows on Wednesday, Thursday, Friday, and Saturday. To fill open slots for the next level of competition (state to regional) from the high-point list, there must be a responsible party at the signup area with an immediate "yes" or "no" response. An exhibitor, parent, grandparent, legal guardian, or Extension agent must be present and prepared to pay entry fees when high-point horses are announced.

Ties for high point horse regional qualifying slots and for filling open slots with high point horses from each day or at the end of the show will be broken in this order: the exhibitor who 1) beats the greatest number of horses in all qualifying classes on a single horse; 2) earned the most points on a single horse in the greatest number of qualifying classes; or 3) earned the most points in performance classes on a single horse.

If an exhibitor has a horse that qualifies for the Southern Regional 4-H Horse Championship and this horse is unable to show because of death, the exhibitor may substitute one of his/her horses for the regional show if the following criteria are met. 1) Exhibitor must provide a copy of a death certificate obtained from a licensed veterinarian to the Extension 4-H Livestock Specialist before the regional horse show entry deadline; 2) Exhibitor must own the substituted horse under the existing Mississippi 4-H Horse Show Rules and Regulations; and 3) Substituted horse must have been exhibited in that year's Mississippi 4-H State Horse Show.

County Stall Decoration/Display Contest Objectives

The objective of the Stall Decoration/Display Contest is to provide 4-H'ers enrolled in the equine projects with an opportunity to display educational information related to the 4-H horse project. The decorations and displays should be exciting and challenging to construct and should be designed so that the 4-H'er can share accomplishments, ideas, requirements, and/or results of special studies in his or her projects.

Counties must enter the County Stall Decoration/Display Contest by Friday, May 24, 2024. Send an email to Dean Jousan at dean.jousan@msstate.edu to enter this contest.

Rules and Regulations

1. All stalls and aisles within each county's stall area will be judged on cleanliness.
2. All decorations must be confined to this designated stall. Signs are permitted on the outside of this stall to identify the county, and all items used in the decoration/display must stay within the confines of the horse stall (i.e., no items above the height of the horse stall).
3. Stall decorations CANNOT include electronics or devices that require electricity to function. Use of nails, liquid nails (or other adhesives), or any other product that causes damage to the stall is prohibited. No painting or discoloration of the stall is allowed. If such damage occurs, the county will be responsible for all expenses to repair the stall and will be automatically disqualified from this contest.
4. No items used to decorate the stall shall be permitted in the alley or walkway of the barn (i.e., chairs, tables, stands, or other objects that take up part of the walkway of each aisle of stalls). All stall decoration/display items must be kept inside the confines of the designated stall for the contest.

5. Stalls must be decorated for judging by 12 noon on Thursday, June 20, and must remain on display until 12 noon on Saturday, June 22. Aisles will be judged for cleanliness during this time, as well.
6. Points will be as follows:
 - a. 20 points: creativity/originality—Educational subject matter pertaining to the equine persuasion, creative design of display, supporting materials, etc.
 - b. 40 points: educational value/context of display—Clarity of message conveys 4-H message, etc.
 - c. 20 points: attractiveness of display—Attracts attention, eye appeal
 - d. 20 points: presentation and cleanliness of display/decorations—General appearance, organization, workmanship, easily understood, cleanliness of stall area, etc.
 - e. Total possible points: 100
7. The top three placing counties will receive plaques awarded the last day of the show.

7. Home Furnishings: Accessories for Your Home. Artwork that you crafted for an accessory for your home. Must be a finished or completed product. Must include an image of a horse.
8. Welded Items: Must not be any larger than 3 by 3 feet. Must include an image of a horse and/or be made of horseshoes. Must be a finished or completed product by the 4-H'er.
9. Digital Art: Must have the original file saved on a thumb drive.

Rules for Horse Art Contest

1. Artwork MUST have been completed since July 1 of previous year.
2. Artwork MUST be the work of the 4-H member submitting the entry/entries.
3. Artwork that documents 4-H horse-related activities is most desirable, but other horse-related activities may be submitted, also. Artwork must have a horse as the primary focus of the work.
4. Artwork MUST meet the following criteria:
 - a. Artwork MUST BE either framed or in a protective sleeve.
 - b. Artwork MUST be DRY and COMPLETE when entered.
 - c. Artwork MUST have a COMPLETED entry form attached to the back of the artwork with required signatures. Entry forms are available at your county Extension office.
 - d. Artwork MUST fit the category entered and adhere to the rules, or will be disqualified.
5. District coordinators must bring all entries between 10 a.m. and noon on Tuesday during the State 4-H Horse Championships at the east end of the Kirk Fordice Equine Center on the Mississippi State Fairgrounds.
6. Winning artwork will be available for viewing from Wednesday to Friday at noon. All artwork must be signed for and picked up (by agent or designated parent/volunteer) on Friday at noon during the State 4-H Horse Show.
7. Age divisions of contestants
 - a. 8–13 years old (as of January 1 of previous year)
 - b. 14–18 years old (as of January 1 of previous year)
8. Awards (in each category)

First, second, and third placesmedallions

*Junior and **senior championsmedallions

(*All first-place junior winners competing)

(**All first-place senior winners competing)
9. Judging

Artwork will be judged on the following criteria. Note: All artwork not adhering to the rules will be disqualified.

Quality of artwork..... 30 points
(Correct technique used for chosen medium, correct composition, etc.)

Attracts and holds attention..... 10 points

Originality /Creativity20 points

Content of artwork..... 30 points
(Appropriate to entry division; clarity of message; value; artwork is subject to disqualification if judges deem it is NOT appropriate for category.)

Horse Art Contest

Objectives

To encourage 4-H members enrolled in the horse project to expand in an area that is rapidly growing as a career and offering opportunities for many 4-H members; to encourage 4-H members who do not have a horse but are interested in horses and related activities.

Categories

NOTE: Multiple entries in a single category by an individual 4-H'er will subject all entries in that category to disqualification. In addition, all horse art contest rules must be adhered to or all entries are subject to disqualification.

1. Pastels/Charcoal/Graphite/Colored Pencil (Abstract or Realistic). Artwork done in pastel, charcoal, graphite, colored pencil, or a combination of these media. Must include an image of a horse or, for abstract, your rendition of a horse. MUST BE PROTECTED TO PREVENT SMEARING.
2. Oil/Acrylic/Watercolor (Abstract or Realistic). Artwork done in oil, acrylic, or watercolor. Must include an image of a horse or, for abstract, your rendition of a horse. MUST BE DRY.
3. Pen/Ink/Markers/Crayon (Abstract or Realistic). Artwork done in pen/ink, marker, crayon, or a combination of these media. Must include an image of a horse or, for abstract, your rendition of a horse. MUST BE PROTECTED TO PREVENT SMEARING.
4. Cartoon (Single Frame or Strip). Artwork done in any medium. Must include an image of a horse and tell a short story or make a point.
5. Sculpture/3-D (Abstract or Realistic). No larger than 2 feet by 2 feet. Artwork done in any 3-D medium. MUST BE DRY when entered. Must be your rendition of a horse.
6. Mixed, Altered Media, Other. (Artwork combining several types of media and that doesn't fit other categories—collage, paper, paint, fun foam, felt, metal, combined mediums, altered horse items, etc.) No larger than 2 feet by 2 feet. Must include an image of a horse. MUST BE DRY when entered.

Presentation of entry 10 points
 (General appearance; artwork is protected by simple matting; correct size; completion of entry form; etc. Artwork is subject to disqualification if rules are not followed exactly.)
 TOTAL POSSIBLE POINTS..... 100 points

Horse Photography Contest

Objectives

To encourage 4-H members enrolled in the horse project to expand in an area that is rapidly growing as a career and offering opportunities for many 4-H members; to encourage 4-H members who do not have a horse but are interested in horses and related activities.

General Rules

- Multiple entries in a single category by an individual 4-H'er will subject all entries in that category to disqualification. All horse photography contest rules must be adhered to or entries may be subject to disqualification.
- All digital and 35mm entries will be judged together in each category.

Categories

NOTE: Multiple entries in a single category by an individual 4-H'er will subject all entries in that category to disqualification.

- Breed Promotion: Horse or Horse and Person**
 A photograph showing the best qualities of a breed; the type of photograph that would be in a "specific breed magazine"; suitable for a story in a magazine or newspaper.
- Action: Horse or Horse and Person**
 A photograph showing ACTION/MOVEMENT of an animal. A photo that catches the moment; not a posed photo.
- Nonaction/Candid: Horse or Horse and Person**
 A photograph showing NO ACTION OR MOVEMENT at all. Very relaxed; may or may not be a POSED photo.
- Human Interest: Horse or Horse and Person**
 A photograph that is creative or comical; something you would want to look at frequently, frame, and hang on your wall; fine art type of photo. These photos may or may not be POSED. Try different lighting techniques.

Rules for Horse Photography Contest

- Photographs MUST have been taken since July 1 of previous year.
- Photographs MUST have been taken by the 4-H member submitting the entry. Agents should authenticate photos if the photographer is in the photo.
- Photographs that document 4-H horse-related activities are most desirable, but other horse-related activities may be submitted, also.
- Photographs MUST have a horse/equid as the primary focus of the picture! Not a picture of a barn cat, a child on a hay bale, a saddle, etc.
- Photographs may be color or black and white.

- Photographs MUST meet the following criteria:
 - MUST BE submitted in a 5-by-7-inch format.
 - Entries MUST be mounted on an 8.5" x 11" white or black piece of cardstock and placed in an 8.5" x 11" sheet protector with the entry form taped to the back of the cardstock. It is permissible to include a supporting item (such as posterboard or cardboard) in the clear plastic page protector to further support the picture. The posterboard or cardboard must be easily removable in the event the picture wins first place.
 - All digital photos MUST include both ORIGINAL and ALTERED photos and be mounted on separate posterboard according to the instructions above. If NO ALTERATIONS are made, a single photo entry is allowed.
 - Attach entry form to photo inside sheet protector (NOT to the outside of the sheet protector). Seal open end of the sheet protector with a piece of tape to keep photo secure inside.
 - NO WRITING or DECORATIONS of any kind will be allowed on the photo or posterboard.
 - Each photograph MUST have a COMPLETED CURRENT entry form attached to back of the posterboard with signatures of the 4-H'er, parent or guardian, and 4-H agent. The agent must have seen and approved all entries prior to submission. Entry forms are available at your county Extension office.
 - Each 35mm photograph MUST have the correct negative in an envelope attached to the back of the entry.
 - Digital photos can be altered and manipulated ONLY by the 4-H'er submitting the entry.
 - Digital photos MUST have a CD or thumb drive attached to the back with all the photo files used to create the photo. Multiple digital photos entered by one 4-H'er may be placed on a single CD or thumb drive and placed with one entry. The consecutive entries must have a highlighted notation on the entry form specifying the location of the photo on the CD or thumb drive.
 - ALL photographs MUST fit the category entered and adhere to ALL rules or will be disqualified.
- District coordinators must submit all entries between 10 a.m. and noon on Tuesday during the State 4-H Horse Championships at the east end of the Kirk Fordice Equine Center on the Mississippi State Fairgrounds. Winners will be announced during the opening ceremonies.
- All photography entries must be signed for and picked up (by agent or designated parent/volunteer) on Friday at noon of the State 4-H Horse Show.
- Age divisions of contestants
 - 8-13 years old (as of January 1 of previous year)
 - 14-18 years old (as of January 1 of previous year)
- Awards (in each category)

First, second, and third placesmedallions

*Junior and **senior championsmedallions

(*All first-place junior winners competing)

(**All first-place senior winners competing)

11. Judging
- Photographs will be judged on the following criteria. Strict adherence to the above rules will be followed.
- Picture quality 30 points
(Focus, depth of field, placement of subject, lighting, etc.)
- Attracts and holds attention..... 10 points
- Originality/Creativity 20 points
- Content of photograph 30 points
(Appropriate to entry division; documents a 4-H horse-related activity; clarity of message; value. Photo is subject to disqualification if judges deem it is NOT appropriate for the category.)
- Presentation of entry 10 points
(General appearance; correct mounting as stated in rules; completion of entry form; etc. Photo is subject to disqualification if rules are not followed exactly.)
- TOTAL POSSIBLE POINTS..... 100 points

- Attracts and holds attention.....30 points
- Originality/Creativity20 points
- Content of T-shirt..... 30 points
(Clarity of message; value. T-shirt is subject to disqualification if judges deem it conveys an inappropriate message.)
- Presentation of entry20 points
(General appearance, correct size)
- TOTAL POSSIBLE POINTS..... 100 points

Horse T-shirt Design Contest

Objectives

To encourage 4-H members enrolled in the horse project to use their creative abilities to design a T-shirt that promotes the 4-H horse program; to encourage 4-H members who do not have a horse but are interested in horses and related activities.

Rules for Horse T-shirt Design Contest

- Each 4-H county is allowed to submit one printed T-shirt that promotes the 4-H horse program to its District 4-H Horse Show. If a county has multiple horse clubs, that county will have to decide the one t-shirt to submit to represent that county.
- The T-shirt can be a screen print, a handmade design, monogrammed, or whatever the club chooses for the design.
- Each district 4-H horse show is allowed to send the top five T-shirts to the state 4-H horse championships to be judged.
- The entry for this contest must be an actual printed T-shirt, not a screen image or design.
- T-shirts that have inappropriate designs, sayings, or other content not suitable for the 4-H horse program are subject to disqualification by the rules committee. All T-shirt contest rules must be adhered to or entries will be subject to disqualification.
- Entries will be accepted from 10 a.m. until noon on Wednesday of the State 4-H Horse Championships at the east end of the Kirk Fordice Equine Center on the Mississippi State Fairgrounds. Winners will be announced during the opening ceremonies.
- All T-shirt entries must be signed for and picked up (by agent or designated parent/volunteer) on Friday at noon during the State 4-H Horse Show.
- Judging
T-shirts will be judged on the following criteria. Strict adherence to the above rules will be followed. All T-shirts not adhering to the rules will be disqualified.

Swazye Woodruff Memorial All-Around Award Mississippi 4-H Horse Shows

Juniors and seniors are eligible for this award.

An exhibitor must compete in one of the contest events (nonriding) at the state 4-H horse show (or district horse show for juniors) to compete for the All-Around Award. These contests will make the 4-H'er eligible: Horse Judging, Horse Public Speaking, Horse Individual Demonstration, Horse Team Demonstration, Horse Bowl, and Hippology.

To be eligible, an exhibitor must compete in at least three events in three or more categories on the same horse. Points will be totaled on one horse (not cumulative of all horses entered by the 4-H'er). In the event of a tie, the winner is the exhibitor who—

1. beat the greatest number of horses in all classes, or
2. earned the most points in the greatest number of classes, or
3. earned the most points in performance classes.

The categories are as follows:

Category I

Halter

Category II

Reining

Western Riding

Trail

Saddle and Gaited Trail

Ranch Trail

Category III

Ranch Sorting

Barrel Racing

Pole Bending

Stake Racing

Category IV

Jumping

Working Hunter

Dressage

Category V

Western Pleasure

Pony Pleasure

Hunter Under Saddle

Pony Hunter Under Saddle

Padded Saddle Horse

Country Pleasure

Saddle Horse Pleasure

Racking Horse

Ranch Riding

Ranch Pleasure

Category VI

Calf Roping

Breakaway Roping

Team Roping-Heading

Team Roping-Heeling

Goat Tying

Working Cow Horse (boxing only)

Ranch Roping

Category VII

Showmanship at Halter

Ground Handling

Western Horsemanship

Hunt Seat Equitation

Saddle Seat Equitation

Equitation Over Fences



Publication 821 (rev-04-24)

Revised by **Clay Cavinder**, PhD, Professor and Extension Horse Specialist, and **Dean Jousan**, PhD, Extension Professor and 4-H Livestock Specialist, Animal and Dairy Sciences.

Produced by Agricultural Communications.

Mississippi State University is an equal opportunity institution. Discrimination in university employment, programs, or activities based on race, color, ethnicity, sex, pregnancy, religion, national origin, disability, age, sexual orientation, gender identity, genetic information, status as a U.S. veteran, or any other status protected by applicable law is prohibited.

Extension Service of Mississippi State University, cooperating with U.S. Department of Agriculture. Published in furtherance of Acts of Congress, May 8 and June 30, 1914. ANGUS L. CATCHOT JR., Director