

Colony Growth and Seasonal Management of Honey Bees

Management of honey bees varies based on whether pollination or honey production is the primary objective. A simple scheme for those interested in maximizing honey production can be a template for any beginning beekeeper. Managing honey bees involves seasonal manipulations of hive space to provide room when necessary for the expanding brood-rearing area and for storage of surplus honey. Good management includes reducing colony space during periods of dearth of incoming food, preventing swarming of bees, feeding food supplements to offset any shortcomings in winter stores or to help stimulate brood production during critical periods of colony development, keeping young and good-quality queens in colonies, and managing diseases and parasites.

Basic Growth Cycle

Good seasonal management begins with understanding that honey bee colony growth depends on rate of incoming food. Nectar and pollen are the staples of the honey bee's diet. Nectar is converted to honey, which is the primary energy source for individual bees and the colony as a collective group. A priority for most beekeepers is to manage bees in such a way as to encourage them to collect and store more honey than the colonies need to survive. The beekeeper harvests the surplus while ensuring the bees have enough stores for surviving dearth in either the summer or winter.

Although honey is essential food for bees, colonies cannot grow without sufficient amounts of incoming pollen. Pollen contains the essential amino acids, sterols, minerals, and vitamins that bee larvae need to grow into adult honey bees. Bee colonies cannot grow without brood production, and brood production hinges on good-quality nutrition that comes from pollen. Hence, bee colonies grow largest during or just after periods of maximum numbers of blooming plants in the spring and autumn (Figure 1). These periods are called honey flows.

Blooming of food plants can be predicted by a crude geographic rule of adding a 1-week delay in bloom for every 200 miles or so northward in latitude. For example, if sumac is blooming heavily in southern Mississippi during the first week of May, a person living near the Mississippi-Tennessee border might expect sumac to bloom from the third week of May into the beginning of June. Why is this important? Many beekeeping activities during the year are directed toward maximal honey production, which depends on the availability of nectar and pollen from major bee forage plants.

Honey yield also depends on colony size. In many ways, the size of your honey crop is determined by your autumn management, overwintering success, and early spring management. Any failure to get colonies ready for the period of primary bloom can mean the difference between a bumper crop and having to feed your bees to survive the remainder of the year.

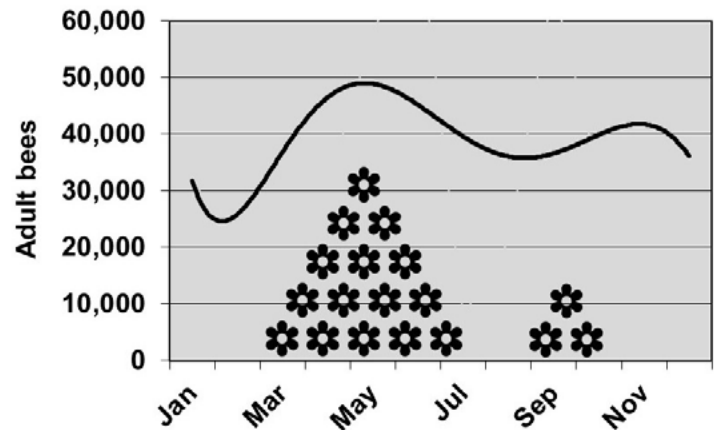

Figure 1. Growth of honey bee colonies depends on the abundance and quality of incoming pollen resources during periods of intense bloom in the spring and autumn. The spring blooming period is usually more intense and of longer duration than the autumn bloom period.

Autumn Management and Overwintering

In the early autumn, hopelessly weak colonies should be combined to avoid losing hive equipment to pests like the small hive beetle or the greater wax moth. However, colonies that are diseased by *Varroa* mites or *Nosema* or any contagious disease should not be placed onto stronger colonies because of the risk of spreading viral, fungal, and bacterial diseases to the stronger unit. It is best to simply kill these colonies by placing them in freezers to save the combs from pests. Fire ants can be encouraged to clean debris out of the combs once the bees are dead. Additionally, combs can be soaked in a dilute bleach solution to kill pathogens. Combs treated in this manner must be thoroughly rinsed and dried before they are given to bees again.

The presence of a good egg-laying queen should be confirmed in all colonies during early autumn. Queens that are more than 2 years old should be replaced to ensure that young, good egg-laying queens will head all colonies in the upcoming spring season. Some people requeen in the spring, while others prefer requeening in the autumn. Biologically, it does not really matter when it is done. However, many authors claim that autumn requeening is best for ensuring that a good young queen is in each colony before the next spring, and that the colonies perform better in early spring than otherwise. A limiting factor may be the time of year for best availability of commercial queens. Try to buy your queens from reputable sources with gentle stock that has some disease resistance.

The late summer and early autumn period (end of August through October) are very important periods for the production of adult worker bees that will form the wintering clusters in your colonies. Winter bees are physiologically different from summer bees. They have more fat in their bodies, and they can survive several months of winter clustering. The best winter bees are

produced during autumn blooms of pollen-rich plants like goldenrod, asters, iron weed, smart weed, and others. These bees not only survive several months of winter, but they retain the ability to secrete protein-rich food that is fed to bee larvae well beyond the typical nursing age of summer bees. Winter bees can become nurse bees in late winter when the queen lays eggs again and bee larvae need to be fed. In many ways, winter bees are a nutritional resource that is essential for not only surviving the winter but for initiating brood production and colony growth into the next spring.

The best winter bees are also produced in disease-free colonies, especially those that have low populations of *Varroa* mites. *Varroa* mite populations should not be very high during winter bee production because the mites vector viruses to the developing bees that will reduce their lifespans. High mite loads in September and October can translate into high numbers of virus-infected winter bees that do not survive the winter. The entire colony can die before January.

The primary focus of this publication is seasonal management and not a lengthy discussion of integrated pest management (IPM) for this parasite; however, some highlights of *Varroa* IPM need to be mentioned (detailed information is in [Extension Publication 2826 Managing Varroa Mites in Honey Bee Colonies](#)). One common way to control *Varroa* mites is to use miticides, but these chemicals contaminate combs and produce adverse health effects in bees that may reduce the lifespans of winter bees. These miticides should not be used when growing your winter bees.

The key idea behind IPM is that decisions to use chemicals for controlling pests are based on sampling the pest population and only treating when a critical threshold has been reached. Threshold levels reflect a population that, if not treated, could quickly grow to damaging levels that cause economic injury to your hive. These decisions need to be made in early summer (July) so that chemical treatments can be removed before winter bees are produced in colonies during September or October.

As autumn progresses, the rate of incoming nectar and pollen eventually declines near the end of October. The size of the brood nest decreases as queens stop laying eggs (**Figure 2A**), and eventually all of the capped brood emerges (usually by mid-November). Once all brood has emerged, only the queen and adult bees occupy the hive. Honey bees do not hibernate during the winter. They survive by clustering together to generate and hold heat (**Figure 2B**). Honey bees consume honey and metabolize the sugars to generate body heat, and without food they will starve to the point that they freeze to death. The ideal situation is to have at least 60 to 65 pounds of

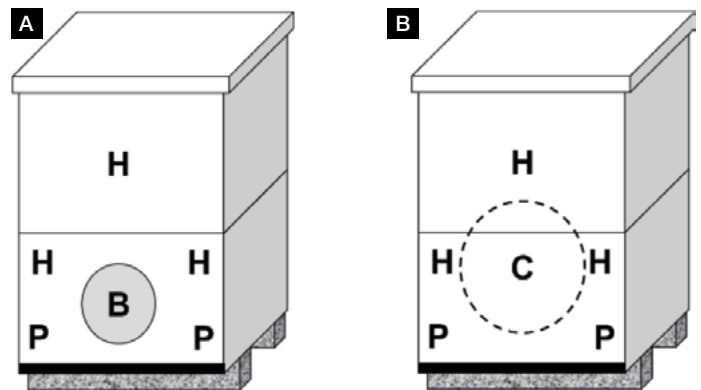

Figure 2. Changes within the brood chambers of honey bee colonies during the autumn.

- A. The brood nest (B) size decreases as the autumn bloom period ends, while amounts of stored pollen (P) and honey (H) increase in the brood nest.
- B. Eventually, all of the brood emerges, leaving only adult worker bees and the queen in a winter cluster (C) that will eat upward through the stored honey to survive the winter.

honey or stored syrup positioned above the cluster of bees in late autumn. The bees will eat upward through a corridor of honey usually near the center of the hive. It is important that your heaviest combs of honey are positioned in the center of the hive body before cold weather occurs.

Supplemental feeding of a heavy sugar syrup (**Table 1**) should be used to boost the food stores in colonies that were short on food for winter survival, and it is best to finish this supplemental feeding by the end of October. There needs to be enough food to keep the cluster from reaching the lid before winter is over (**Figure 3A**). If this happens and no supplemental food is given to the bees, they will starve to death.

Syrup feeding is often used in beekeeping for different purposes. Generally, thin syrups are used to stimulate comb construction and foraging behavior in the spring or early summer months. Heavy syrup is fed during relatively warm weather to make up for shortfalls in stored food needed to survive a dearth period. Feeding syrup in extremely cold weather can chill honey bees because they need to evaporate water (which draws away heat from the cluster) from the syrup to convert it to honey. It is also very important to feed bees forms of sucrose that are nonstimulative during very cold periods so that the bees do not try to forage in extremely cold temperatures.

Table 1. Different recipes for feeding sucrose to honey bees.

Amount of Table Sugar (sucrose)	Amount of Water	Type of Syrup or Candy	Primary Use
4 pounds	1 gallon	Thin syrup (33% sugar)	Stimulative feeding; building comb; queen cell construction; stimulate brood rearing and foraging
8 pounds	1 gallon	Medium syrup (50% sugar)	Spring or summer feeding to help with stores for summer dearth or other shortfalls
16–17 pounds	1 gallon	Heavy syrup (67% sugar)	Autumn feeding to make up shortfall in winter stores
10 pounds	4 cups	Fondant or soft candy	Nonstimulative feeding in autumn or winter
10–15 pounds	3 cups	Hard candy	Nonstimulative feeding in autumn or winter

Figure 3. Running out of food during the winter.

- A. Starvation of a winter cluster (C) can occur if the bees eat most of the stored honey and reach the lid before the cold period has ended.
- B. Candy boards can be installed as an emergency ration of sugar that may save a winter cluster that would otherwise starve.

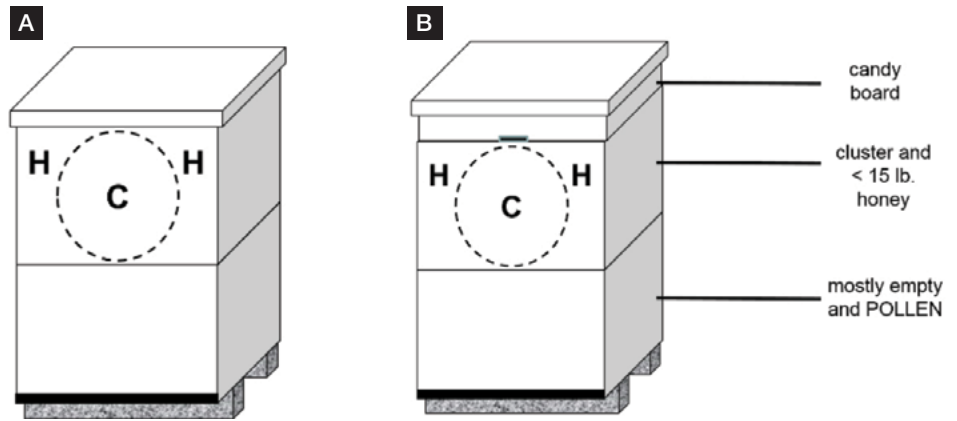

A nonstimulative way to supply emergency food during the winter is to use a candy board that places several pounds of hard sucrose candy (Table 1) or even granulated table sugar over the top bars in case the bees run out of honey (Figure 3B). The hard candy is poured into a modified lid that has an upper entrance, and when the candy hardens, the candy board is placed on top of the hive. If the winter cluster reaches the lid by eating through most of the stored honey, the candy is within reach and can save the bees from starvation. Many northern beekeepers use candy boards, and they check them once a month during the entire winter. During each inspection, they are prepared to remove an empty candy board and replace it with one filled with 6 to 10 pounds of hard candy. These swaps can be made in less than a minute and even in very cold weather.

Be very careful when heating syrups, honey, or solutions to make candy. Heating sugars produces 5-(hydroxymethyl)-furfural (HMF), which is extremely toxic to bees in tiny concentrations. It is best to use syrup or candy recipes that do not call for heating. However, if you choose to heat your sugar solutions, use a candy thermometer and avoid temperatures that may caramelize or degrade the sugars. It is best to bring the water to boiling, and then turn off the heat before adding the table sugar. A mechanical mixer or stirrer may be needed to make the hard candy or fondant, and it will be important to pour the hard candy into the candy board or a mold before it hardens.

Late Winter and Early Spring

Hive inspections in early-January or mid-February are critical to gauge the amount of food stores remaining in hives coming out of the winter. Colonies will do best if they still retain at least 30 pounds of honey from the winter stores. Shortfalls can be offset with hard candy boards or fondant, but when warmer weather returns (early March), a heavy syrup can be fed to bees to carry them through until a good honey flow occurs.

Increasing photoperiod triggers brood rearing, and queens will begin laying eggs in early January in our area (Figure 4). This is a truly critical time for honey bees because the energy demands of the colony greatly increase. Without brood, wintering bees can relax their cluster temperature to well below the normal brood nest temperature of 95°F. Once the queen lays eggs, the worker bees must warm and hold the brood nest to this temperature so bee larvae will develop normally into adult bees. Therefore, wintering bees must consume more honey to sustain the brood nest temperature, and the risk of starvation greatly increases from mid-January through the end of March (until a honey flow begins).

Pollen is readily available from maple and other plants beginning in January in Mississippi, and supplemental feeding of protein or pollen patties (irradiated to kill pathogens is best) is usually not necessary for stimulating brood rearing. However, colonies may benefit from supplement provisions of pollen or protein should inclement weather occur for an extended period of time. It does not really matter which protein supplement is used. Most of the commercially available protein supplements for bees (whether soy-based or albumin-based) may help stimulate and support brood production. For our area, good colony strength in mid-February would equate to at least 3 pounds of bees covering six or more brood frames.

Typically, adult bee populations reach critically high levels needed for maximal honey production by mid-March for southern Mississippi and mid-April for northern Mississippi. Beekeepers frequently report swarms and presence of abundant swarm cells by the end of February and beginning of March in some years. Swarming is indeed the biggest management challenge in March and April. Any colony that swarms is unlikely to have a foraging force large enough to accumulate a harvestable surplus, so swarm prevention is necessary for maximal production from each hive.

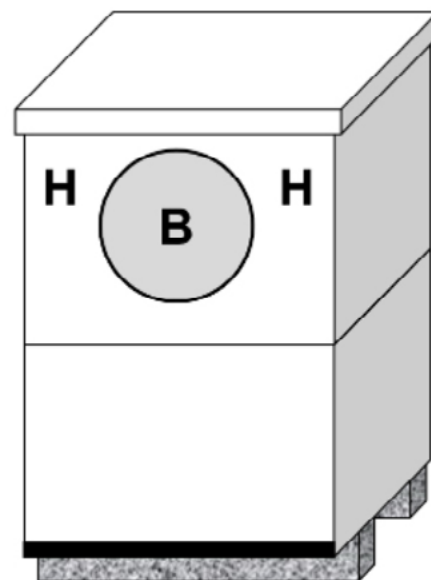

Figure 4. Queens begin to lay eggs again in January, and the winter cluster becomes an active brood nest (B) that will increase the energy demands on the bees.

Swarm Management

Reproductive swarming is an instinctive desire of honey bees to increase their numbers by reproducing at the colony level, doubling their chances of survival. We do not fully understand this behavior, but we know some contributing factors. One of these is congestion in the brood area, which is related to population size and availability of space. Swarming also is associated with the production and distribution of chemicals that the queen secretes. If there is not enough of this pheromone (queen substance), the bees make queen cells to prepare for swarming.

The queen's pheromones are moved throughout the colony when attendant worker bees contact the material by touching their antennae to the queen or by licking her. The chemical signal is then relayed throughout the colony when workers pass molecules of the queen substance to other workers during exchanges of food that often occur among nestmates, or when workers touch antennae during communication. When the signal is distributed throughout the colony in relatively high levels, queen substance inhibits the urge to swarm. As colony size increases, the signal becomes diluted among the worker bee population, and eventually it no longer inhibits the urge to swarm.

During spring inspections, determine the condition of the queen. The colony must have a young, healthy queen that can lay many eggs. A good queen lays a uniform brood pattern according to the strength of the colony, but a failing queen usually scatters her brood and lays drone eggs in worker cells. Colonies with queens more than a year old are more likely to swarm than those with young queens. Older queens produce less queen substance than younger ones. This is why many beekeepers regularly requeen their hives every 1 or 2 years. Even though autumn requeening is best, you must do some requeening in every season.

Additionally, sick queens may not produce enough queen substance, or they produce an abnormal blend of chemicals. The worker bees respond to these poor chemical signals by producing supersedure queen cells in which a daughter queen in the same hive naturally replaces the established and often aging queen. Supersedure queen cells may be produced any time a queen is lost or begins to fail. This may be at a time when colony nutrition is relatively poor, and, in general, queens from supersedure cells may be of poorer quality than those raised from swarm cells that are made during periods of optimal nutrition.

The weather may influence swarming. When colonies are strong and developing rapidly, good weather following a period of bad weather seems to heighten the swarming fever. Other factors that contribute to swarming include poor ventilation, heredity, and an age imbalance in the worker bee population.

Most swarming occurs in April and May in Mississippi, and you need to check the colonies every week during this season. Queen cells in the brood area are the first sign the colony is preparing to swarm or supersede its queen. Swarm cells (**Figure 5A**) are commonly on or near the bottom bars of the combs in the upper brood chamber(s), but supersedure queen cells (**Figure 5B**) generally occur on the face of the comb.

To check quickly for swarm cells, tip back the top brood chamber(s) and look up between the frames (**Figure 6**). Destroy all swarm cells. Unfortunately, cutting out queen cells seldom prevents swarming. It only delays it because the bees usually build more cells in a few days. Once the bees cap a queen cell, they are committed to swarming.

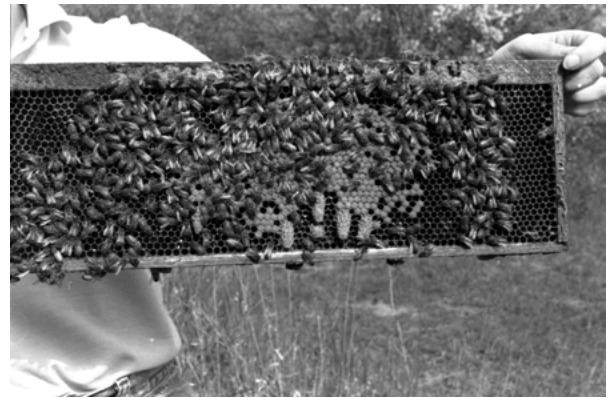

Figure 5A. Swarm cells near the bottom bar of comb.



Figure 5B. Supersedure queen cells on the comb face.



Figure 6. Checking a colony for swarm cells.

Swarming Preparations

In addition to raising one or more queens, colony preparations for swarming include placing the queen on a diet, rearing more drones, and reducing foraging activity by the field force. Since the workers feed the queen less royal jelly during this period, egg laying declines, and the queen's abdomen shrinks, allowing her to fly with the primary swarm when it leaves the hive. Normally, the primary swarm is the old queen, a few drones, and 50 to 60 percent of the workers. Just before coming out of the parent hive, the workers engorge themselves with honey and drive the queen out. Occasionally, other smaller swarms (afterswarms) follow with a newly emerged virgin queen.

Colonies have been known to swarm so many times that they actually swarm themselves to death. A swarm normally comes from the parent hive during nice weather, between 10 a.m. and 2 p.m., and settles on a nearby tree limb, shrub, post, or building. Swarms may stay there only a few minutes or several days before moving to a new cavity selected by scout bees.

Swarm Prevention Methods

Swarming must be controlled for successful beekeeping. Colonies that swarm rarely recover in time to produce a honey crop. Routine management in the spring usually reduces swarming. March and early April are generally the swarm-prevention months. Providing plenty of room in a colony for brood-rearing and the ripening and storage of nectar is essential.

In early spring, the queen is normally locked in the uppermost hive body, which limits the size of the brood area. Swarm prevention begins in mid-March (northern Mississippi) and mid-February (southern Mississippi) with the reversal of hive bodies in the brood chamber (Figure 7A). Generally, the brood nest (B) and remaining stored honey (H) coming out of the winter cluster will be located in the top brood box (2), while the bottom brood chamber (1) will contain empty combs (or with some stored pollen) that were left after the bees had eaten stores and moved the cluster upward during the winter.

Rotating these two chambers moves the empty combs above the developing brood nest, which gives the queen space for laying eggs. Honey bees like to expand the brood nest upward as the colony grows. This rotation of boxes should only be done if the brood nest is located in one box. If it is spread

across two boxes, rotating the boxes will separate combs of brood from one another and create stress on the bees as they try to thermoregulate two sections of brood during cold spring nights (Figure 7B).

Caution: Do not reverse the hive bodies until the weather has settled and there is little chance of a sudden big drop in temperature.

Equalizing the strength of your colonies also helps prevent swarms and makes management easier the rest of the year. Following are ways you can strengthen weak colonies:

- ▶ Change their positions with strong colonies in the same yard.
- ▶ Add sealed brood from strong colonies.
- ▶ Add queenless booster packages of worker bees.
- ▶ Unite two weak colonies.
- ▶ Combine a queenless colony with a queenright colony.

When exchanging bees and brood between colonies, be sure the frames do not contain the queen and that the colonies are not diseased. When adding adult bees to an existing colony, separate them with a sheet of newspaper to let colony odors mix and to keep fighting to a minimum. Such precautions are not necessary for frames of brood. You will not gain much by adding unsealed brood to a weak colony because the colony probably does not have enough nurse bees to care for the extra brood.

Another way to prevent swarming is to divide or split colonies in late March or early April. Split a strong colony into two smaller colonies of about equal size, making sure that the halves get equal numbers of frames of honey, brood, and pollen. A queen cell or new queen may be introduced into the queenless portion at the time of the split. Move the new queen and her colony to another location at least 3 miles away.

Another approach is to remove four to six frames of brood with adhering bees from the strong colonies and place them in separate hives (nucleus colonies). Provide them with a queen or queen cell, additional food, and bees. You can place each split near the parent colony, but they will do better if you move them to a new location. The parent colony rarely swarms after such treatment if given enough space, and the new division usually becomes a productive unit when established early in a year with a good nectar flow.

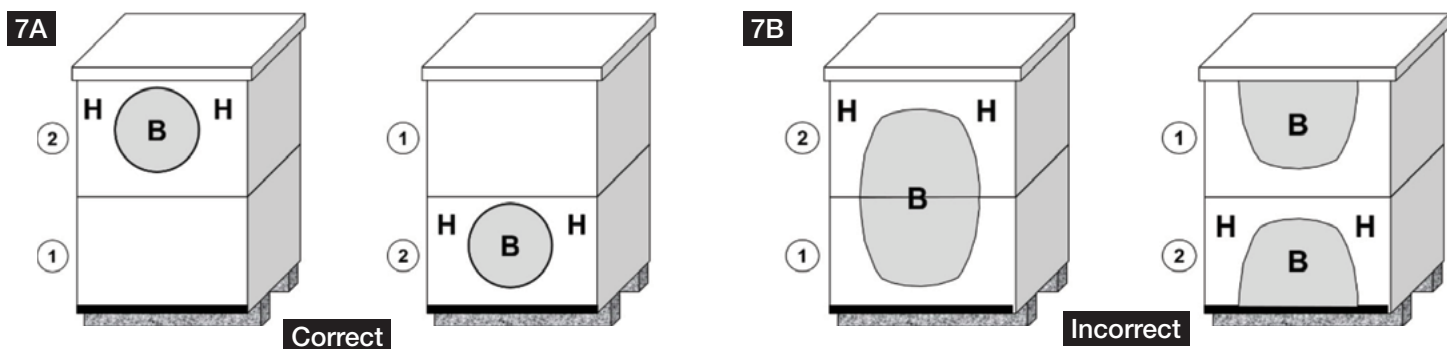

Figure 7. Swarm prevention begins in early spring with a reversal of hive bodies that puts empty combs above the active brood nest (B), which begins in the upper hive body as the bees eat through the winter stores up toward the lid. Do not reverse hive bodies if brood is present in both the upper and lower hive bodies.

Swarm Control

Once a colony is committed to swarming (queen cells are present), more drastic action is required to control swarming. The best way to treat a colony with queen cells is to make a division or split the colony within the same hive by using a double screen (**Figure 8**). Place the old queen with three to five frames of unsealed brood in the bottom brood chamber. Add an extra hive body with empty combs and honey. Place the double screen on top of the second hive body with the entrance facing the rear of the hive. Above it, put the second brood chamber containing five or six frames of brood, mostly sealed, and two combs of pollen and honey on each side. Shake additional bees from the lower hive body into the upper portion because field bees will return to the lower brood chamber.

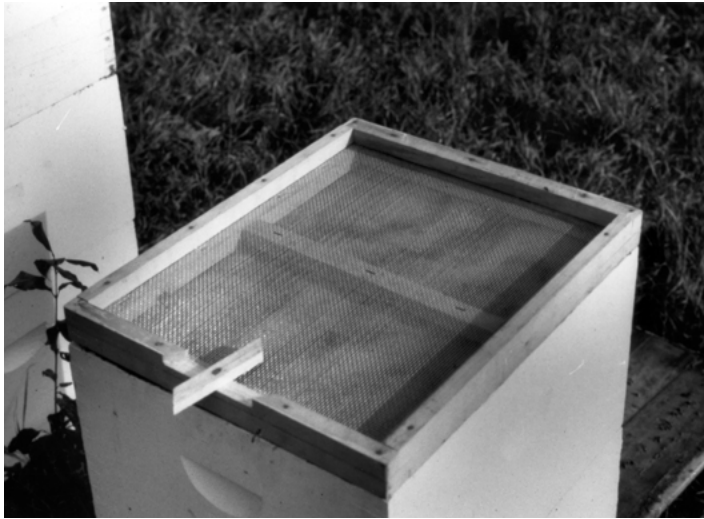

Figure 8. A double screen is a wooden frame holding two layers of wire screen, usually 8-mesh, about a half-inch apart, to separate bees in the hive.

Bees in the lower hive body destroy any queen cells, while the bees above the double screen raise a new queen. Colonies treated in this manner rarely swarm. After the swarming season, reunite the two units by removing the double screen. This is an excellent way to requeen the parent colony. You can move the top hive body with the new queen to make a new colony or strengthen a weak hive.

Using a double screen is also an excellent way to split colonies before the swarming impulse develops. When you use this technique to make divisions early in the spring, introduce a new queen or ripe queen cell to the upper portion.

Another technique to stop swarming is the Demaree method of separating the queen from the brood. This lets rapid colony growth continue but takes a lot of hard work and time. Examine all frames of brood in the colony and destroy all queen cells. Place the queen in the lower brood chamber and all frames of uncapped brood (eggs and larvae) in the upper brood chamber. You can keep capped brood in the upper or lower brood chamber. Place one or two hive bodies full of empty combs between the original two brood chambers. Before adding the middle supers, place a queen excluder (metal or plastic device with spaces that permit the passage of workers but restrict the movement of drones and queens to a specific part of the hive) on top of the bottom hive body. The colony is now at least three boxes high:

- ▶ The first box contains the queen, empty combs, and some capped brood.
- ▶ The middle hive bodies contain empty combs and perhaps a frame or two of capped brood.
- ▶ The top box contains the young, uncapped brood frames.

Under the Demaree procedure, uncapped brood in the top box attracts most young nurse bees away from the old brood nest in the bottom box, which relieves the crowding. Empty comb in the bottom hive body provides plenty of space for the queen to continue laying. More space opens up as the capped brood emerges. In 7 to 10 days, return to inspect the colony and destroy any new queen cells that may have developed in the upper hive bodies.

Making Space for the Honey Crop: Supering

Give colonies extra space by adding hive bodies (supers) in the spring or early summer before they need more space. There must be enough good combs available for brood-rearing and storing honey. Add empty combs to the brood nest. A super is usually needed by the time of fruit bloom, and a strong colony in late spring may need the equivalent of three deep hive bodies just to provide enough room for the adult bees.

By late spring, it is time to add your first empty honey super (HS). Once the height of the swarming season has passed (end of April to early May), you will need to provide enough space for nectar storage. When conditions are perfect, bees can fill honey supers in 2 to 3 days, so it will be important to stay ahead of the storage needs of your hive by supering. Honey production depends on the quality of the bloom. In a typical year, weather conditions may permit near optimal production. Obviously, unusual weather conditions such as droughts or lengthy periods of rain during what should be the blooming period can diminish yields.

Your hives should be placed in close proximity to adequate plant sources to secure your crop. In northern Mississippi, the major nectar plants available in May are rattanvine, privet, tulip poplar, and white clover. For southern Mississippi, major nectar sources include privet, palmetto, yaupon holly, rattanvine, highbush gallberry, and sumac. Blue vervain, sumac, sourwood, cotton, white clover, and peppervine are major nectar sources in northern Mississippi in June. White clover, cotton, summer titi, palmetto, Chinese tallow, and sumac are the major nectar sources for southern Mississippi during the same period.

Almost all commercial beekeepers use queen excluders (**Figure 9**) to prevent brood production in the honey supers. The reason is that the cost for the labor of removing frames of brood from honey supers during the extraction process would be too prohibitive. The excluders guarantee that queens do not put brood into the boxes of honey. Many beekeepers do not use queen excluders because they feel that the obstructive nature of these screens adds to the congestion in the nest that triggers swarming. Usually, these are small-scale beekeepers who can devote more labor and time to only a few colonies to try and keep brood out of the honey super. They use a full honey super as a barrier to the upward movement of the queen. Queens do not like to cross combs of honey to look for a place to lay eggs. However, if a queen puts some brood in a few frames of the first honey super, those combs are replaced with full frames of honey, and the brood is moved upward into the second additional honey super. The brood will emerge before the honey

flow is over, and the bees will fill the emptied brood cells with honey. The full honey super below will prevent the queen from wandering into any additional honey supers (assuming that all supers are added to the top).

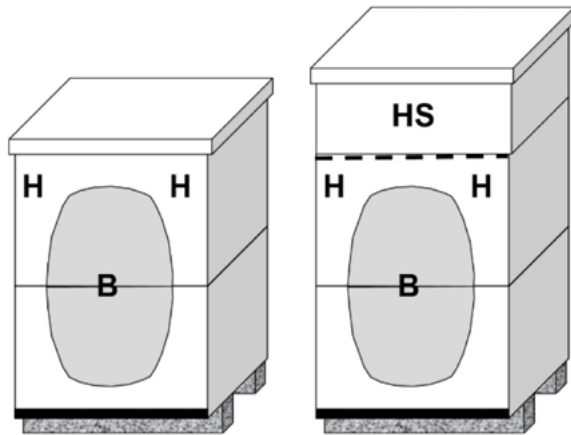

Figure 9. Boxes for honey storage are called supers (HS). Many commercial beekeepers place them above queen excluders (dotted line) to keep brood out of the honey combs.

Many Southern beekeepers use the two-thirds full rule as a guide for when to put on the next super. Simply stated, when six combs of a 10-frame honey super are full (or nearly full), it is time to place another empty super onto the hive. By early summer, many commercial beekeepers add the empty super to the top (Figure 10), while some small-scale beekeepers with more time (and stronger backs) will place the empty super below the nearly full one. There is no published data that suggests a difference in honey production between top- and bottom-supering methods. Either method works—just do what feels right for you! Supering will continue from mid- to late summer until the availability of nectar and pollen diminishes and the brood nest shrinks in size. By the middle or end of June, the harvest of the honey crop can begin.

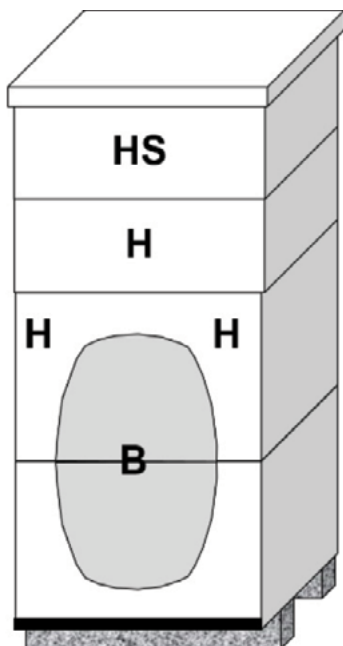

Figure 10. Most commercial beekeepers place the next super (HS) on top of one that is already partially filled. This is called top-supering.

Summer Management

Most beekeepers in this area will begin harvesting honey in July. Small-scale beekeepers will typically produce more honey per colony because they can manage each unit more intensively for optimal production. The testament for your skills in spring management will be the soreness of your back by the middle of July! In early summer, the brood nest usually occupies at least two hive bodies (Figure 11A). Eventually, the late summer honey flow slows, and the egg-laying rates of queen bees decrease. This results in a reduction in the brood nest. Often, the bees will back-fill portions of the brood nest with honey, and the brood nest can become restricted to one hive body during the late summer (Figure 11B).

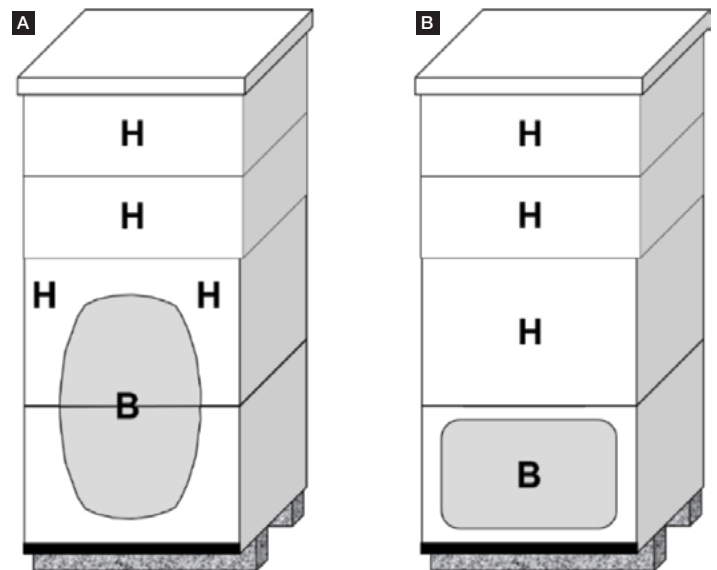

Figure 11. Changes in hive conformation during the summer.
A. Early summer hive with expanded brood nest.
B. Late summer hive with one of the brood chambers back-filled with honey.

As a beekeeper, you may have to make a decision about how much honey to extract. For example, do you take all three boxes of honey from the colony in Figure 11B, or do you leave the bees one box to survive a dearth in food that will occur during July into August? If you take all of the honey, be prepared to feed the bees a heavy syrup to ensure their survival. The economics of beekeeping may dictate that you sell all of the honey possible and feed the bees a cheaper sucrose syrup. Whatever your decision, you must provide food for the summer dearth.

Another important consideration is not to return honey supers to colonies of bees when there is no honey flow. There is a tendency to want to store boxes of extracted combs on living colonies in order to protect the combs from damage caused by comb pests like the greater wax moth and the small hive beetle. However, colony size usually decreases during the summer dearth, and it stresses a colony of bees when they try to patrol and protect large stacks of supers placed above them. Many colonies will be unable to adequately protect the combs, and the two comb pests can overrun the equipment that the beekeeper was trying to protect. Many beekeepers will put supers of newly extracted or wet combs onto hives temporarily for a day or so to allow the bees to lick and store the honey residue. Once the combs

are dry, the supers can be removed for storage. It is best to cycle combs in and out of freezers to kill the eggs or larvae of the two comb pests, and then store the combs on repellents like para-dichlorobenzene (for example, Paramoth; always follow the directions).

The growth of honey bee colonies is predictable, and once the autumn honey flow begins, the brood nest will once again expand as the colony grows. Eventually the bloom ends, and the colony will again have a reduced brood nest (Figure 2A) to begin the cycle all over again. Although the patterns of colony growth are fairly predictable, each year and new season may vary from historical norms. As a beekeeper, your job will be to adapt your management scheme to fit unusual weather or other situations that affect the availability of nectar and pollen to your bees.

The information given here is for educational purposes only. References to commercial products, trade names, or suppliers are made with the understanding that no endorsement is implied and that no discrimination against other products or suppliers is intended.

Publication 2941 (POD-08-23)

By **Jeffrey W. Harris**, PhD, Associate Extension/Research Professor, Biochemistry, Molecular Biology, Entomology, and Plant Pathology. Some material from a retired publication by Clarence H. Collison, PhD, Professor Emeritus, Entomology.

Copyright 2023 by Mississippi State University. All rights reserved. This publication may be copied and distributed without alteration for nonprofit educational purposes provided that credit is given to the Mississippi State University Extension Service.

Produced by Agricultural Communications.

Mississippi State University is an equal opportunity institution. Discrimination in university employment, programs, or activities based on race, color, ethnicity, sex, pregnancy, religion, national origin, disability, age, sexual orientation, gender identity, genetic information, status as a U.S. veteran, or any other status protected by applicable law is prohibited.

Extension Service of Mississippi State University, cooperating with U.S. Department of Agriculture. Published in furtherance of Acts of Congress, May 8 and June 30, 1914. STEVE MARTIN, Interim Director